



# iSOLAR

powered by **DAB** and **iCON**  
WATER • TECHNOLOGY

## DAB iCON Solar Bore SELECTION GUIDE



[whiteint.com.au](http://whiteint.com.au)  
[whiteint.co.nz](http://whiteint.co.nz)





**Steps to follow:**

- 1. Best practice installation guide
- 2. Performance curves of respective pump
- 3. Check Pump/Wet-end selection with respect to
  - a. Motor size
  - b. Head range
- 4. Cable size selection
- 5. Checks and guides to follow
- 6. iSOLAR Selection Matrix - AU
- 7. iSOLAR Selection Matrix - NZ
- 8. iSOLAR V3 controller timer features

**SOLAR INSTALL DATA**

No. of Solar Panels: \_\_\_\_\_ Invoice #: \_\_\_\_\_

Total Input Solar Wattage: \_\_\_\_\_ W (No. of solar panels X Watts per solar panel) Pump Model: S4 \_\_\_\_\_

Connection type: Series  Parallel  Motor Serial #: \_\_\_\_\_

Installation type: Option 1  \_\_\_\_\_

Option 2

Option 3  (Refer to step 1: Installation guide)

Cable size: \_\_\_\_\_ mm<sup>2</sup>

Cable length: \_\_\_\_\_ meters

Total Voc\*: \_\_\_\_\_ V (Max: 440 Voc)

Total Amps: \_\_\_\_\_ A (Max ISC\*: 12A DC; 10A AC)

\*Voc: Voltage open circuit

\*ISC: Short circuit current

Date of Install: \_\_\_\_\_

Duty: \_\_\_ Lpm @ \_\_\_ m Total Head

**Please note: The Solar Install Data must be returned to White International to register for warranty**

AUSTRALIA  
Email: [aftersales@whiteint.com.au](mailto:aftersales@whiteint.com.au)  
Phone: 1300 783 601

NEW ZEALAND  
Email: [sales@whiteint.co.nz](mailto:sales@whiteint.co.nz)  
Phone: 0800 509 506

Document dated: 01-June-2020



# 1. Best Practice Installation Guide

## Option: 1

System using Mechanical float switch, Pressure switch, Flow sensor, Pressure tank, Non-Return Valve

- Pressure switch requires use of pressure tank and Non return valve.
- System guarantees longest operational life
- Backup power supply support
- Complete Low voltage circuit for input sensors

### DC & AC POWER WIRING

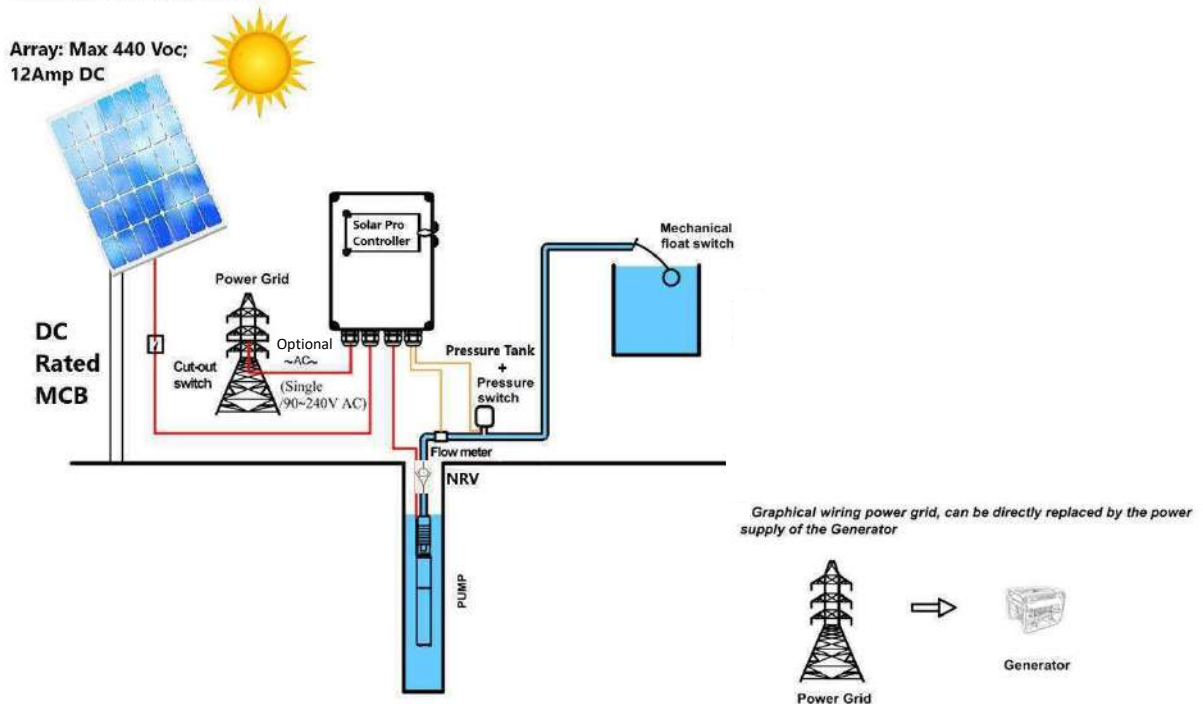

\*\*Your site installation must follow options 1, 2 or 3 to facilitate the warranty process

## Option: 2

### System using Electronic float switch, Flow sensor, Non-Return Valve

- Electronic Float activates system, extra protection with flow sensor
- System guarantees longest operational life
- Backup power supply support

#### DC & AC POWER WIRING

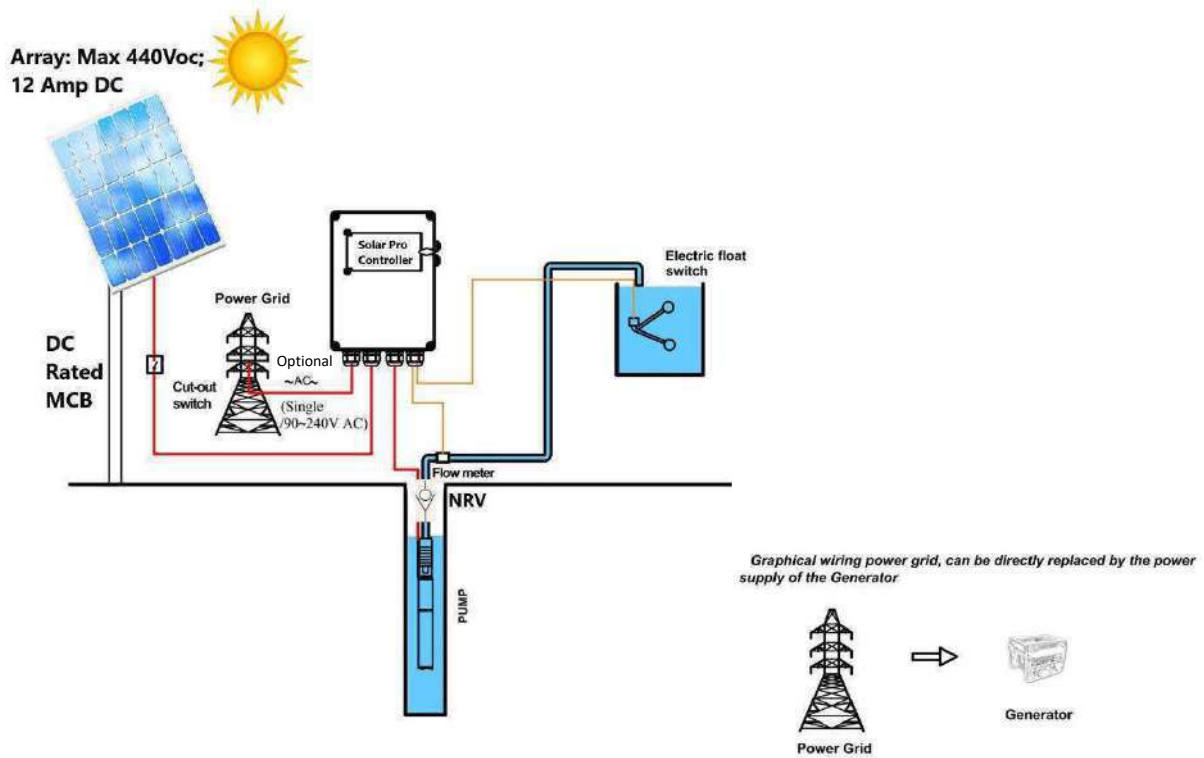

\*\*Your site installation must follow options 1, 2 or 3 to facilitate the warranty process



### Option: 3

#### System using Non-Return Valve and Flow sensor

- System runs as long as power is available, shuts off with zero flow
- Continues to restart using timer in control
- System guarantees longest operational life
- Backup power supply support

#### DC & AC POWER WIRING

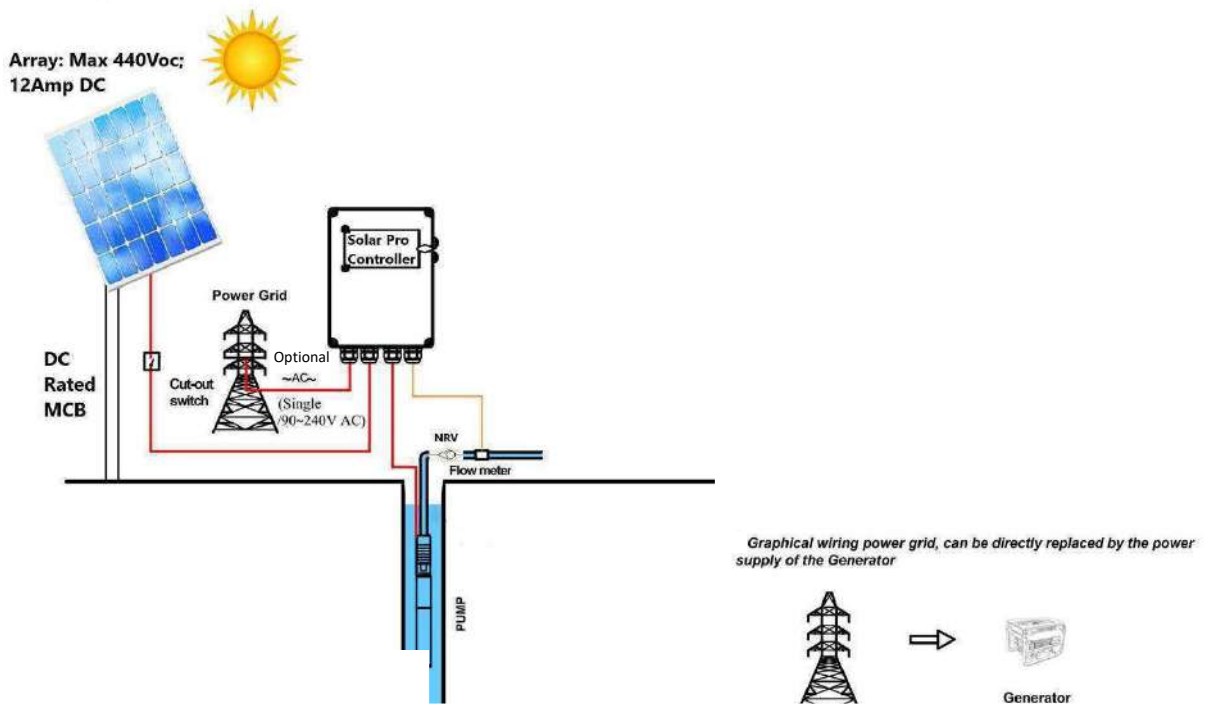

\*\*Your site installation must follow options 1, 2 or 3 to facilitate the warranty process

# 4" BOREHOLE PUMPS - SOLAR POWERED

## Performance Curves

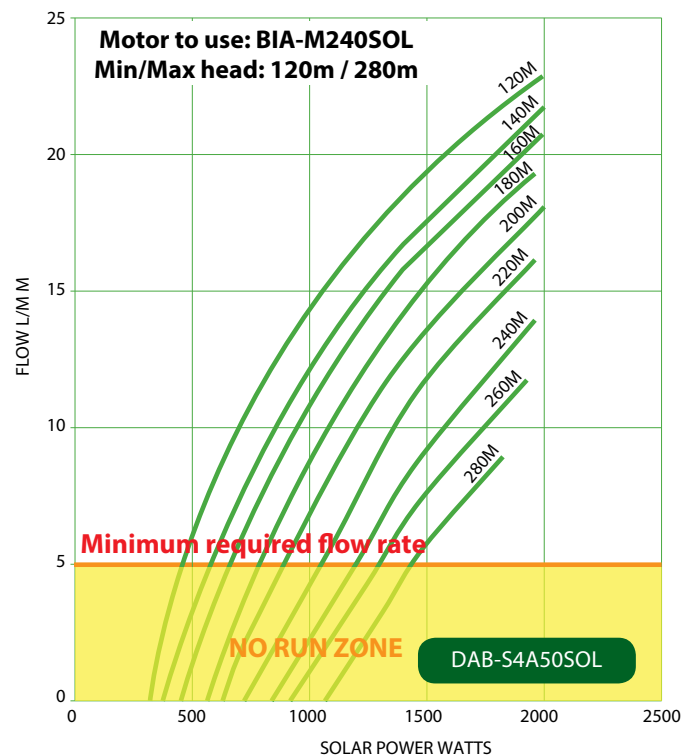
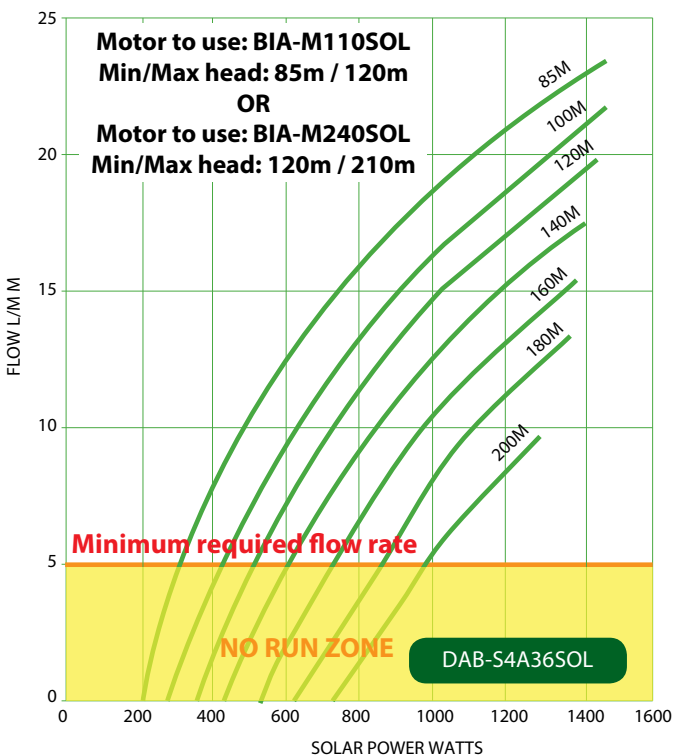
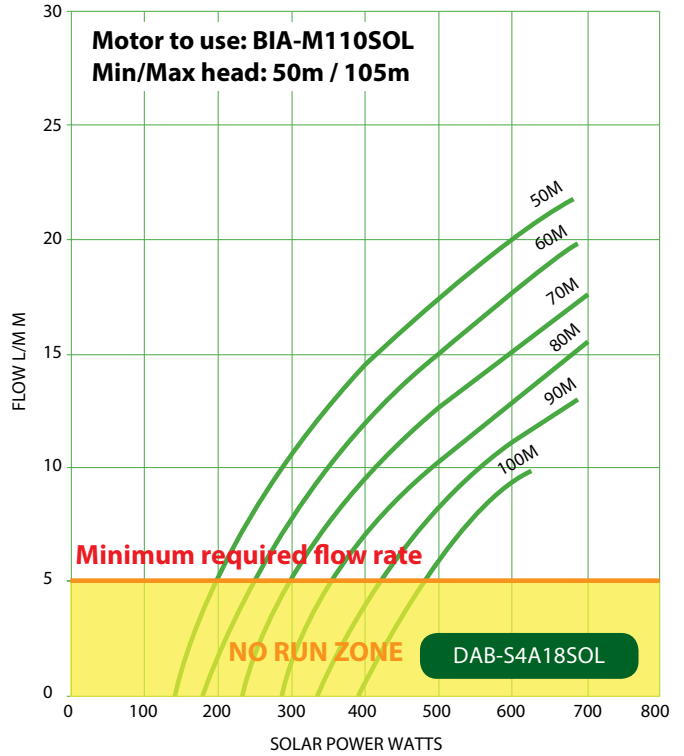
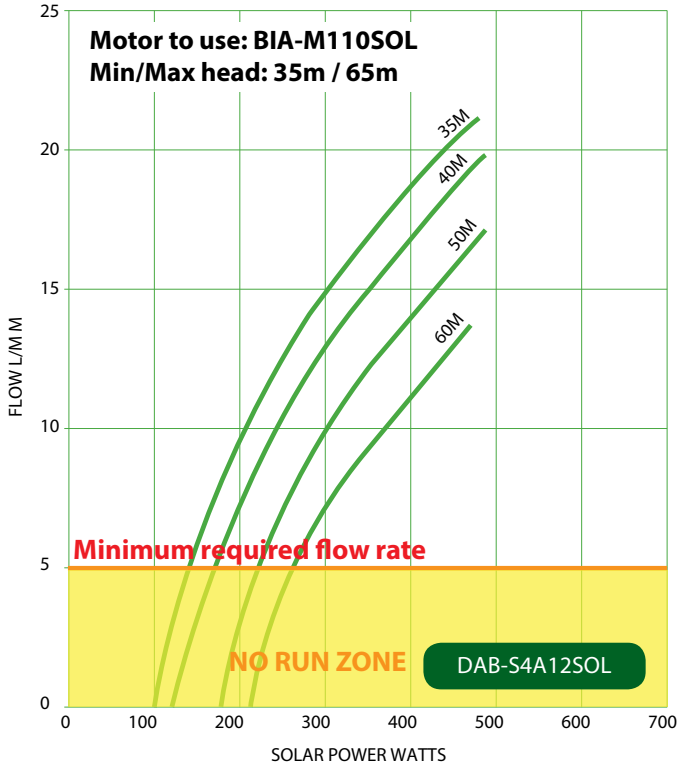



# 4" BOREHOLE PUMPS - SOLAR POWERED

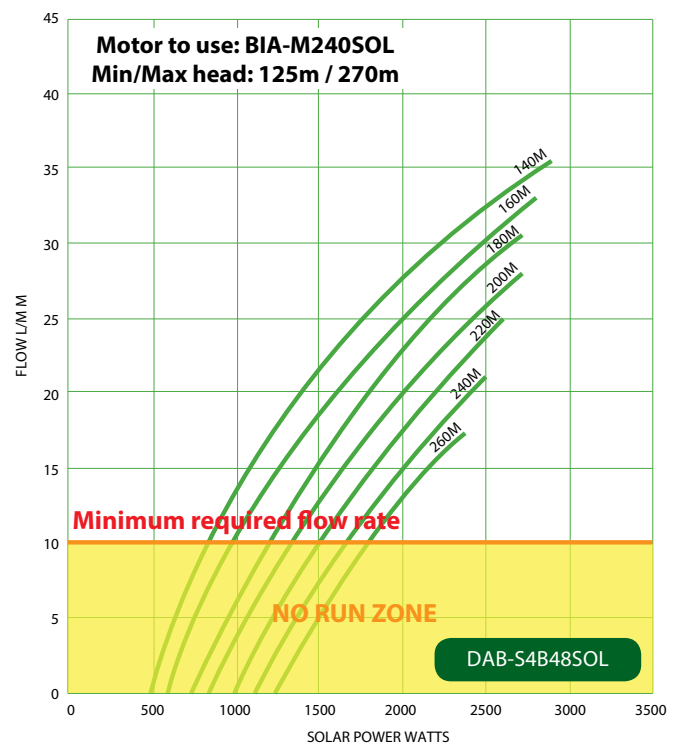
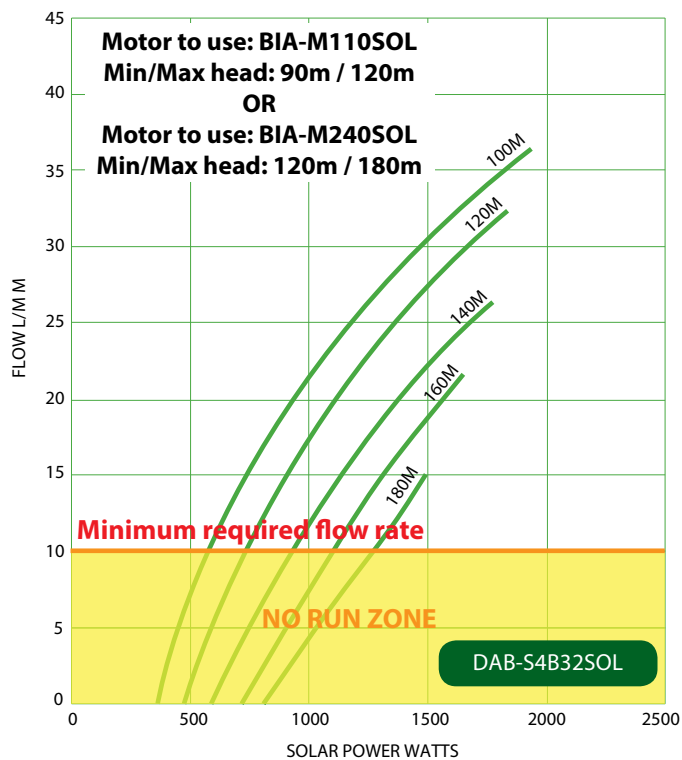
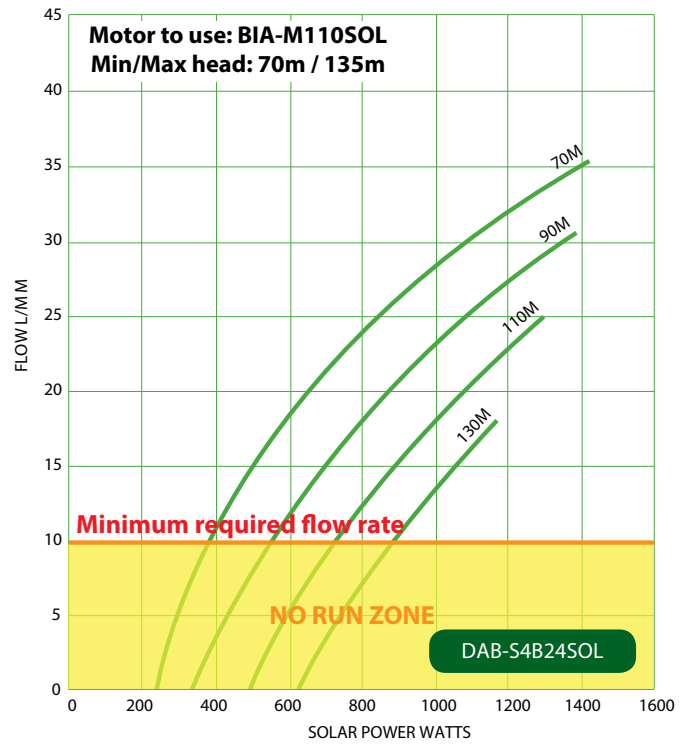
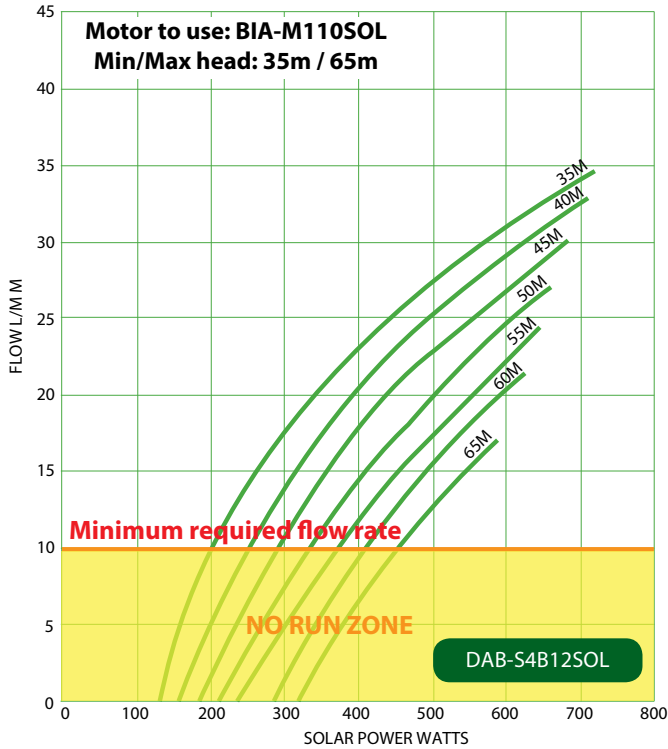

# 4" BOREHOLE PUMPS - SOLAR POWERED

## Performance Curves

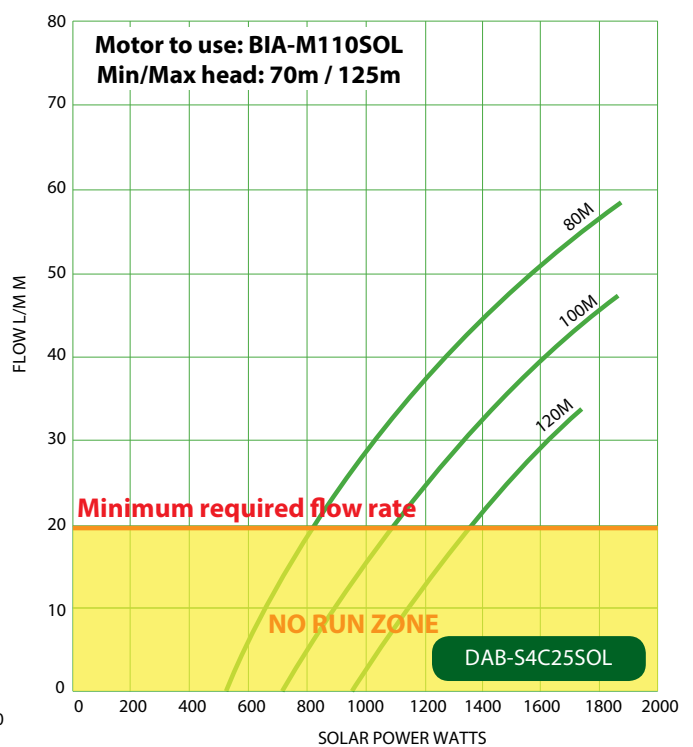
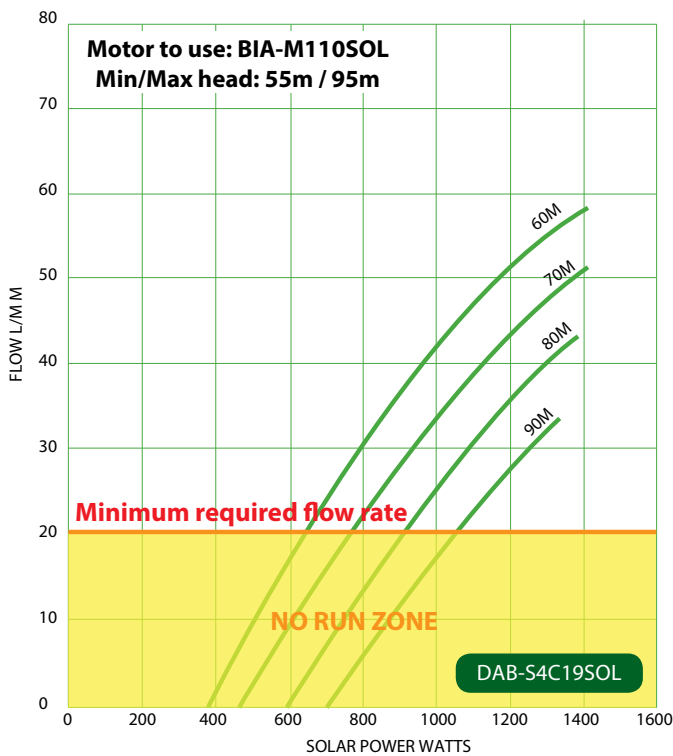
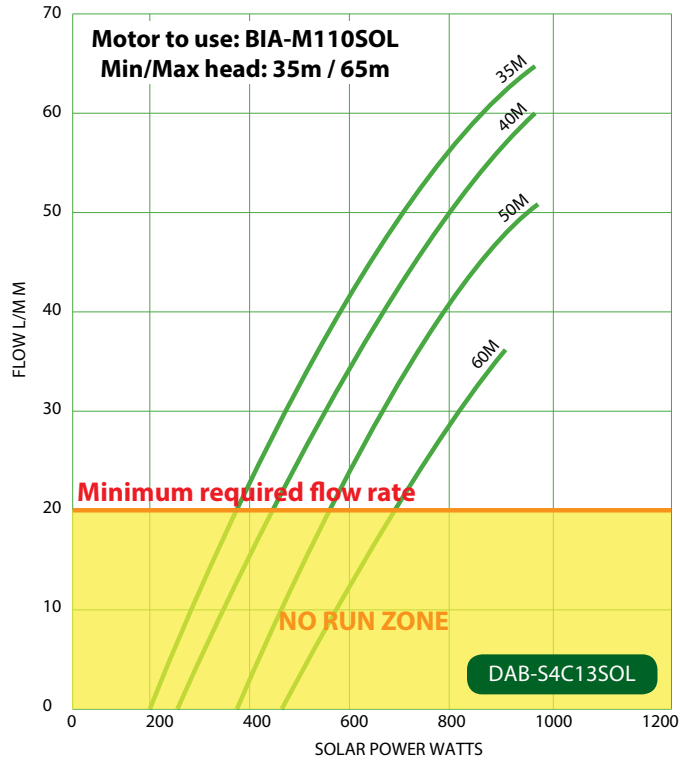
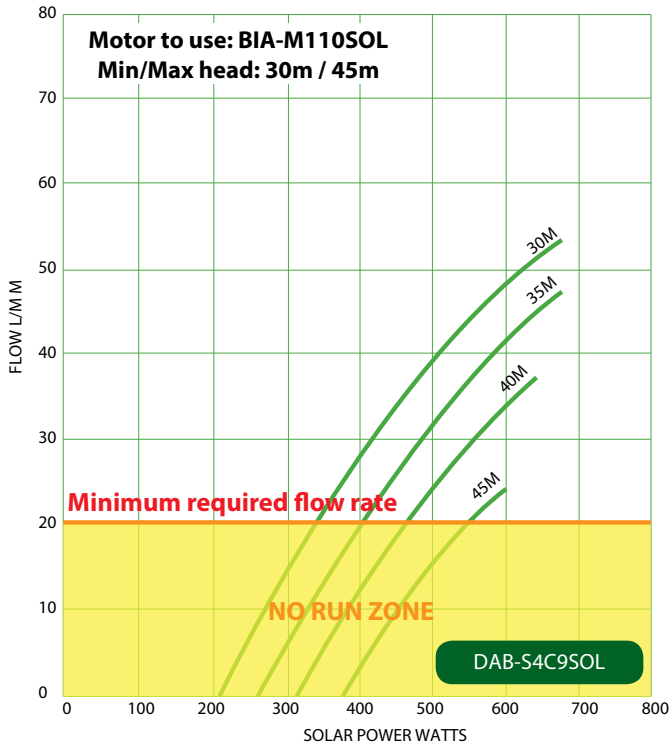

# 4" BOREHOLE PUMPS - SOLAR POWERED

## Performance Curves

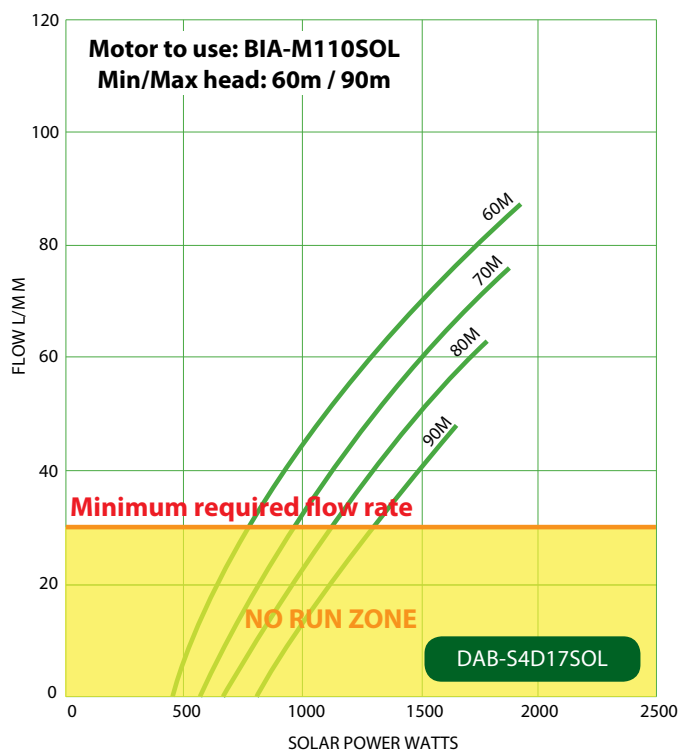
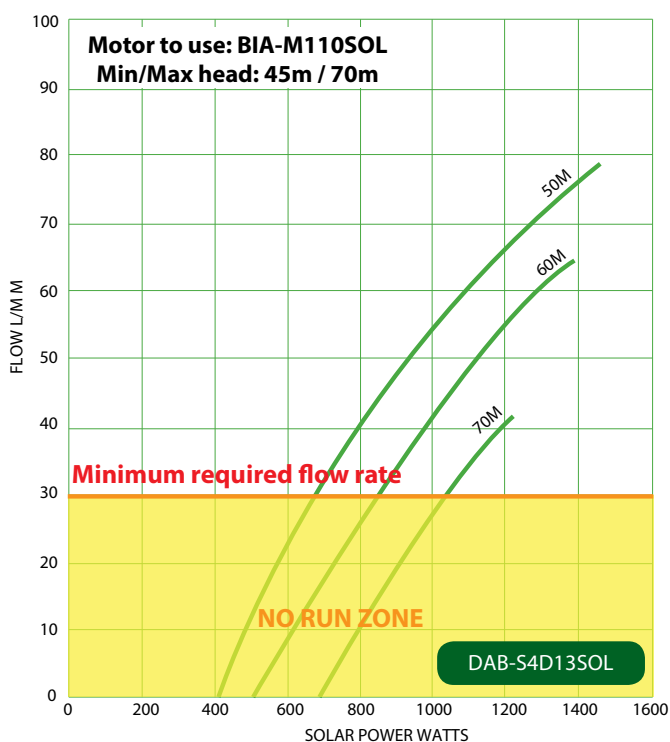
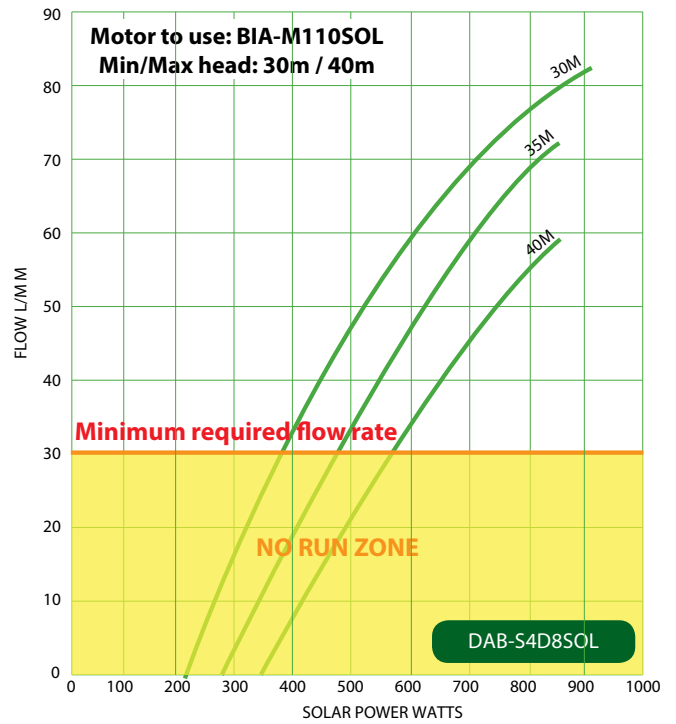
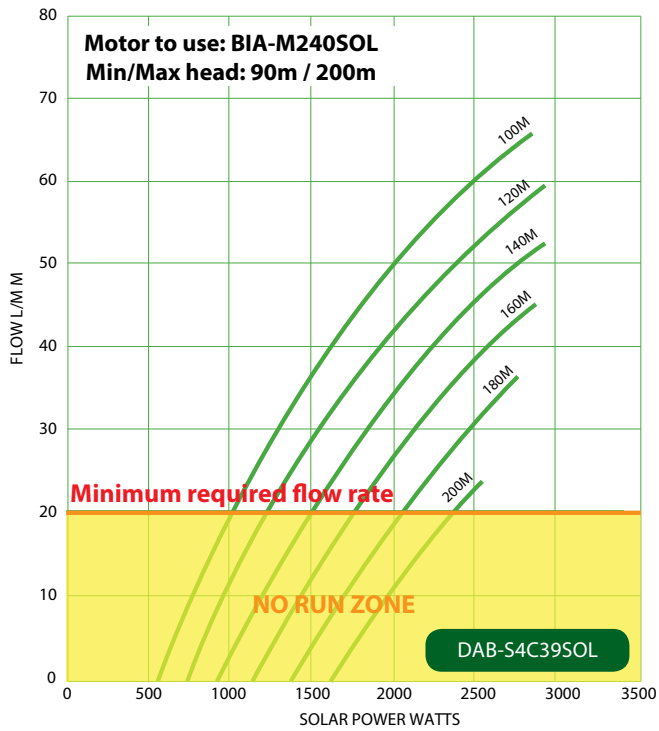

# 4" BOREHOLE PUMPS - SOLAR POWERED

## Performance Curves

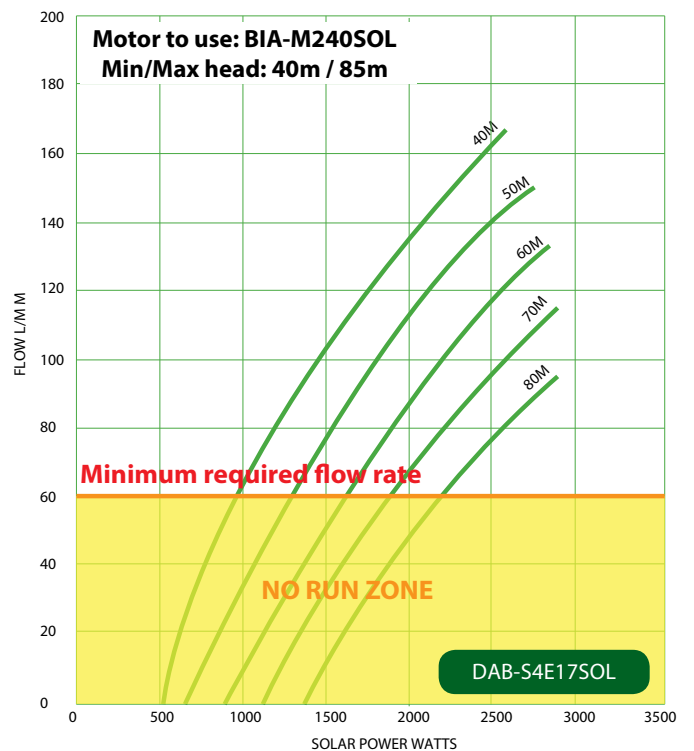
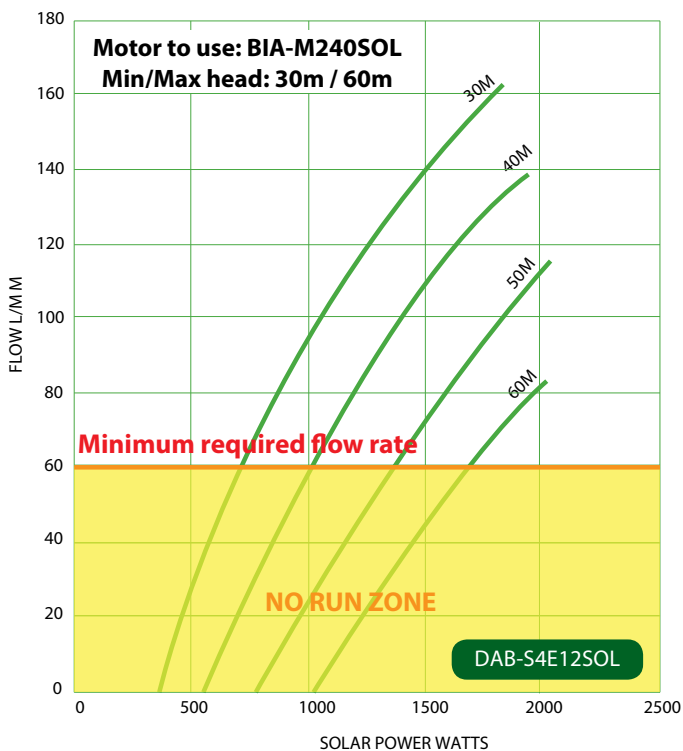
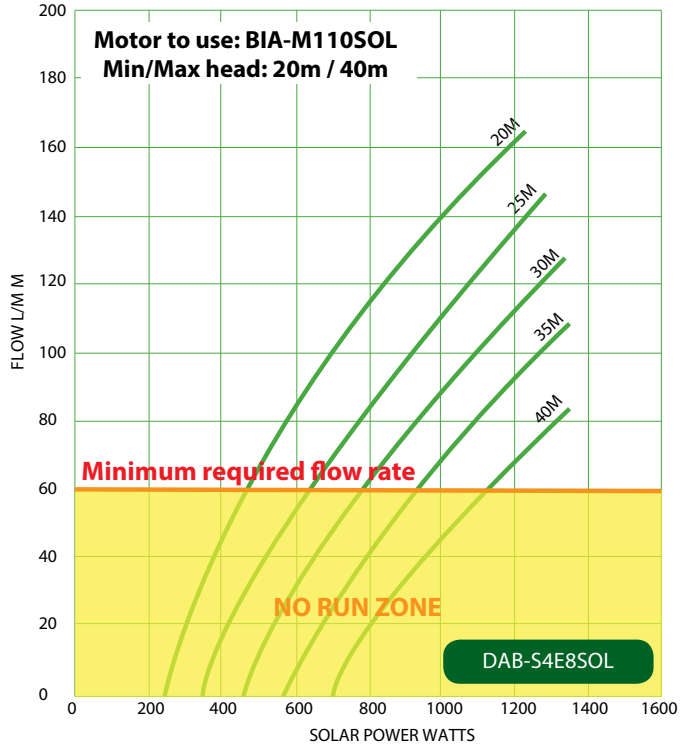
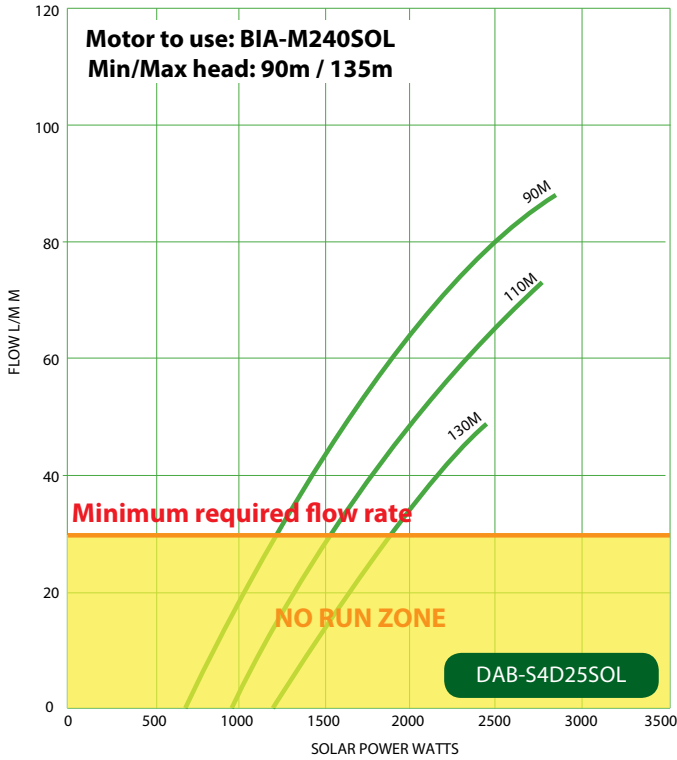

# 4" BOREHOLE PUMPS - SOLAR POWERED

## Performance Curves

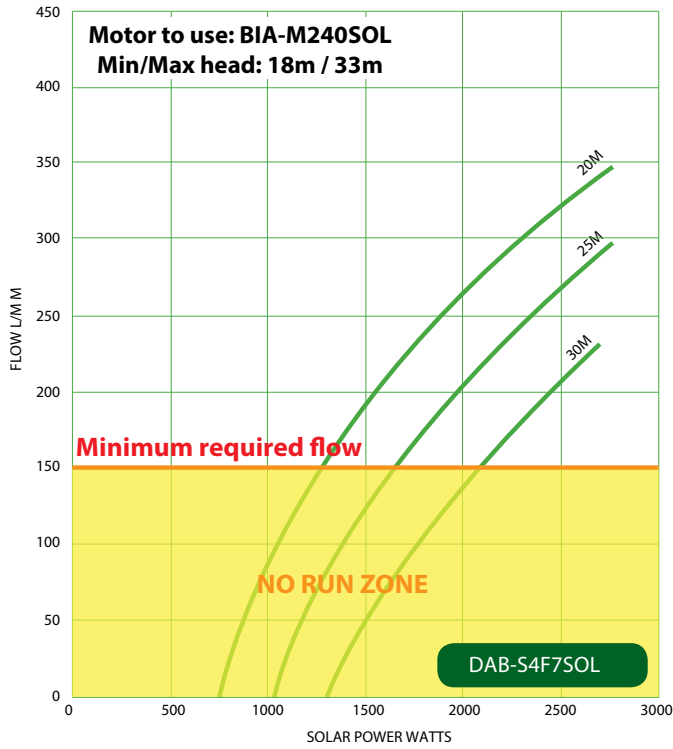

### 3. Pump Selection with respect to Motor Size, Head Range

Sl. #	Pronto Code	Pump Model	Recommended Motor Sizes	Head Range
1	802619	DAB-S4A12SOL	BIA-M110SOL	35m to 65m
2	805147	DAB-S4A18SOL	BIA-M110SOL	50m to 105m
3	805150	DAB-S4A36SOL	BIA-M110SOL	85m to 120m
4	806196		BIA-M240SOL	120m to 210m
5	805148	DAB-S4B12SOL	BIA-M110SOL	35m to 65m
6	805151	DAB-S4B24SOL	BIA-M110SOL	70m to 135m
7	805364	DAB-S4B32SOL	BIA-M110SOL	90m to 120m
8	806197		BIA-M240SOL	120m to 180m
9	805155	DAB-S4B48SOL	BIA-M240SOL	125m to 270m
10	805149	DAB-S4C9SOL	BIA-M110SOL	30m to 45m
11	802620	DAB-S4C13SOL	BIA-M110SOL	35m to 65m
12	805152	DAB-S4C19SOL	BIA-M110SOL	55m to 95m
13	805365	DAB-S4C25SOL	BIA-M110SOL	70m to 125m
14	805156	DAB-S4C39SOL	BIA-M240SOL	90m to 200m
15	802621	DAB-S4D8SOL	BIA-M110SOL	30m to 40m
16	805153	DAB-S4D13SOL	BIA-M110SOL	45m to 70m
17	805366	DAB-S4D17SOL	BIA-M110SOL	60m to 90m
18	805146	DAB-S4D25SOL	BIA-M240SOL	90m to 135m
19	805154	DAB-S4E8SOL	BIA-M110SOL	20m to 40m
20	805367	DAB-S4E12SOL	BIA-M240SOL	30m to 60m
21	805145	DAB-S4E17SOL	BIA-M240SOL	40m to 85m
22	805144	DAB-S4F7SOL	BIA-M240SOL	18m to 33m
23	806033	DAB-S4A50SOL	BIA-M240SOL	120m to 280m



## 4. CABLE SIZING CHART

Solar Panel Input			Cable length (Upto 'X' Meters)									
DC Input Power Watts	Vmpp Volts	Imp Amps	10	25	50	75	100	125	150	200	250	300
			CROSS SECTION MM <sup>2</sup>									
600	60	10	2.5	6	16	25	25	35	35	50	70	70
900	90	10	1.5	4	10	16	16	25	25	35	50	50
1200	120	10	1.5	4	6	10	16	16	25	25	35	35
1500	150	10	1.5	2.5	6	10	10	16	16	25	25	35
1800	180	10	1.5	2.5	4	6	10	10	16	16	25	25
2100	210	10	1.5	2.5	4	6	10	10	10	16	16	25
2400	240	10	1.5	1.5	4	6	6	10	10	16	16	25
2700	270	10	1.5	1.5	2.5	4	6	10	10	10	16	16
3000	300	10	1.5	1.5	2.5	4	6	6	10	10	16	16
3300	330	10	1.5	1.5	2.5	4	6	6	10	10	16	16

**\*\*\*This chart is to be used as a guide only, exact cable size will vary according to the input characteristics and technical specifications of the solar panel**  
 Please refer to our iSOLAR web selector for your selection - [www.isolarselector.whiteint.com.au](http://www.isolarselector.whiteint.com.au) OR [www.isolarselector.whiteint.co.nz](http://www.isolarselector.whiteint.co.nz)

**Step1:** Select your DC input power (Total wattage available from all the solar panels used for your system)

**Step2:** Under the Cable length column, choose corresponding length of the cable in meters and select the correct cable size.

**Voc:** Voltage Open Circuit  
**Vmpp:** Voltage at Max Power  
**Isc:** Short Circuit Current  
**Imp:** Current at Max Power

### Solar Panel wiring:

Wiring shown for 10 solar panels connected in series. Note that operational DC input voltage ranges from 55 Vmpp to 380 Vmpp (Max: 440 Voc)

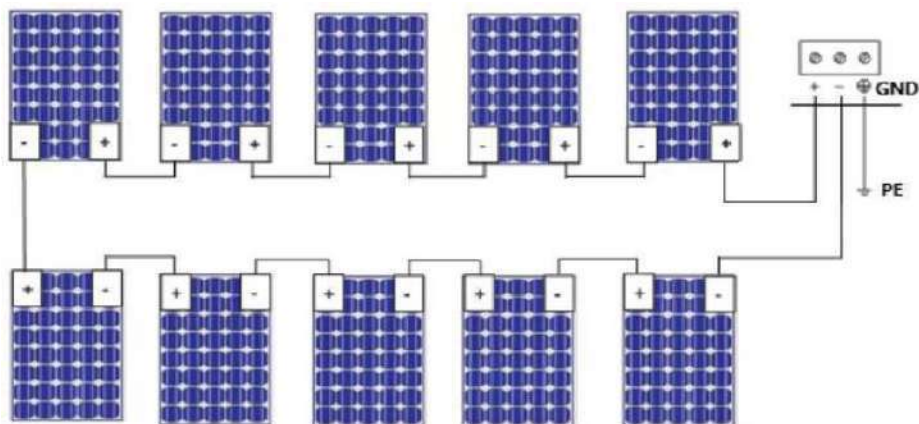



## 5. Checks and guides to follow:

### a. DryrunprotectionwithpressuresystemsontheiCONSolarmotors:

The motor has a software protection to prevent shutdown, so if there is no water or if it's a closed head it could take up to 30min before it shuts off completely. It is hence recommended that a best-case system install must include the iSOLAR controller, motor and flow meter on a pressure system. When using a pressure switch system, it must include a correctly sized expansion vessel and non-return valve, apart from the one installed inside the pump end.

### b. Shroudingduringahorizontalinstall:

We recommend a shroud must be used for all applications (but can be used without a shroud as well). But a shroud must be used when the current drawn by the motor is above 2kW. To estimate motor consumed wattage, consider the total power of the solar panels and then less 30%.

Rule of thumb: Above 2kW = Use shroud; If below 2kW = Not compulsory.

*Example:* If the total size of the solar array is 3000W, less 30% = 2100W. At peak power, it is expected to be above 2kW, hence use a shroud.

*During a horizontal install, the minimum angle of install shouldn't be negative (i.e. pump end shouldn't point downwards) and the bleed hole must be in the upright position.*

### c. Pumpendtolerances:

To ensure successful long-term motor operation, it is crucial that the pump has the correct amount of movement in its shaft. Once the motor and pump have been assembled, we can confirm that the permitted movement on the spline must be 1mm to 2 mm.

### d. Shafttensions:

When manipulating the shaft without power the shaft may appear to be tight. BIA-M240SOL motors have a tighter shaft due to the magnetic force required to support up to 320m head.

### e. Over-sizingarrays:

Max power of the solar arrays must not exceed 440Voc & 12Amps - DC Power.

### f. Sizingupagenerator:

Take total kW of the solar array, multiply by 1.1 and then divide by 0.8 to arrive at the minimum kVA required from the generator.

### g. If using a roof mount array (NZ Only):

Because the most common structure is a wooden frame, the panels and mounting system have no direct path to earth. In the event of lightning strike, the earth path is entirely via the combiner box. Hence we suggest to install an earth strap to ground stake (6mm<sup>2</sup> or larger)

### h. Warranty:

To be inspected for warranty, the motor must be returned with cable and joint intact. We recommend the cable be cut at least a minimum of 100mm above the joint kit.

# 6. iSOLAR SELECTION MATRIX - AU

For Australia

HEAD M	iSOLAR BOREPUMP SELECTION BASED ON AVERAGE 6 SOLAR HOURS/DAY SUMMER, 4 SOLAR HOURS/DAY WINTER												LITRES/MIN, LITRES/DAY									
	400 W		600 W		800 W		1000 W		1200 W		1400 W		1600 W		2000 W		2400 W		2800 W		3200 W	
	SUMMER	WINTER	SUMMER	WINTER	SUMMER	WINTER	SUMMER	WINTER	SUMMER	WINTER	SUMMER	WINTER	SUMMER	WINTER	SUMMER	WINTER	SUMMER	WINTER	SUMMER	WINTER	SUMMER	WINTER
20			S4E8SOL 84	S4E8SOL 84	S4E8SOL 115	S4E8SOL 115	S4E8SOL 140	S4E8SOL 140	S4E8SOL 161	S4E8SOL 161	S4E8SOL 165	S4E8SOL 165										
			30240	20160	41400	27600	50400	33600	57960	38640	59400	39600										
20											S4F7SOL 185	S4F7SOL 185	S4F7SOL 215	S4F7SOL 215	S4F7SOL 261	S4F7SOL 261	S4F7SOL 308	S4F7SOL 308	S4F7SOL 350	S4F7SOL 350		
											66600	44400	77400	51600	93960	62640	110880	73920	126000	84000		
30	S4C9SOL 27	S4C9SOL 27	S4C9SOL 48	S4C9SOL 48																		
	9720	6480	17280	11520																		
30			S4D8SOL 60	S4D8SOL 60	S4D8SOL 75	S4D8SOL 75																
			21600	14400	27000	18000																
30							S4E8SOL 88	S4E8SOL 88	S4E8SOL 112	S4E8SOL 112	S4E8SOL 128	S4E8SOL 128										
							31680	21120	40320	26880	46080	30720										
30					S4E12SOL 76	S4E12SOL 76	S4E12SOL 96	S4E12SOL 96	S4E12SOL 112	S4E12SOL 112	S4E12SOL 128	S4E12SOL 128	S4E12SOL 147	S4E12SOL 147	S4E12SOL 163	S4E12SOL 163						
					27360	18240	34560	23040	40320	26880	46080	30720	52920	35280	58680	39120						
30																	S4F7SOL 191	S4F7SOL 191	S4F7SOL 230	S4F7SOL 230		
																	68760	45840	82800	55200		
40	S4A12SOL 16	S4A12SOL 16	S4A12SOL 20	S4A12SOL 20																		
	5760	3840	7200	4800																		
40	S4B12SOL 21	S4B12SOL 21	S4B12SOL 28	S4B12SOL 28	S4B12SOL 33	S4B12SOL 33																
	7560	5040	10080	6720	11880	7920																
40			S4C9SOL 34	S4C9SOL 34	S4C9SOL 37	S4C9SOL 37																
			12240	8160	13320	8880																
40			S4C13SOL 38	S4C13SOL 38	S4C13SOL 50	S4C13SOL 50	S4C13SOL 60	S4C13SOL 60														
			13680	9120	18000	12000	21600	14400														
40					S4D8SOL 55	S4D8SOL 55																
					19800	13200																
40									S4E8SOL 68	S4E8SOL 68	S4E8SOL 84	S4E8SOL 84										
									24480	16320	30240	20160										
40					S4E12SOL 60	S4E12SOL 60	S4E12SOL 81	S4E12SOL 81	S4E12SOL 99	S4E12SOL 99	S4E12SOL 117	S4E12SOL 117	S4E12SOL 140	S4E12SOL 140								
					21600	14400	29160	19440	35640	23760	42120	28080	50400	33600								
40					S4E17SOL 49	S4E17SOL 49	S4E17SOL 67	S4E17SOL 67	S4E17SOL 82	S4E17SOL 82	S4E17SOL 95	S4E17SOL 95	S4E17SOL 108	S4E17SOL 108	S4E17SOL 133	S4E17SOL 133	S4E17SOL 180	S4E17SOL 180				
					17640	11760	24120	16080	29520	19680	34200	22800	38880	25920	47880	31920	64800	43200				

ISOLAR BOREPUMP SELECTION BASED ON AVERAGE 6 SOLAR HOURS/DAY SUMMER, 4 SOLAR HOURS/DAY WINTER												LITRES/MIN, LITRES/DAY											
HEAD M	400 W		600 W		800 W		1000 W		1200 W		1400 W		1600 W		2000 W		2400 W		2800 W		3200 W		
	SUMMER	WINTER	SUMMER	WINTER	SUMMER	WINTER	SUMMER	WINTER	SUMMER	WINTER	SUMMER	WINTER	SUMMER	WINTER	SUMMER	WINTER	SUMMER	WINTER	SUMMER	WINTER	SUMMER	WINTER	
50	S4A12SOL 13 4680	S4A12SOL 13 3120	S4A12SOL 16 5760	S4A12SOL 16 3840																			
50	S4A18SOL 14 5040	S4A18SOL 14 3360	S4A18SOL 20 7200	S4A18SOL 20 4800																			
50	S4B12SOL 15 5400	S4B12SOL 15 3600	S4B12SOL 25 9000	S4B12SOL 25 6000	S4B12SOL 27 9720	S4B12SOL 27 6480																	
50			S4C13SOL 24 8640	S4C13SOL 24 5760	S4C13SOL 40 14400	S4C13SOL 40 9600	S4C13SOL 50 18000	S4C13SOL 50 12000															
50					S4D13SOL 40 14400	S4D13SOL 40 9600	S4D13SOL 53 19080	S4D13SOL 53 12720	S4D13SOL 66 23760	S4D13SOL 66 15840	S4D13SOL 76 27360	S4D13SOL 76 18240											
50											S4E12SOL 63 22680	S4E12SOL 63 15120	S4E12SOL 82 29520	S4E12SOL 82 19680	S4E12SOL 113 40680	S4E12SOL 113 27120							
50											S4E17SOL 72 25920	S4E17SOL 72 17280	S4E17SOL 88 31680	S4E17SOL 88 21120	S4E17SOL 112 40320	S4E17SOL 112 26880	S4E17SOL 134 48240	S4E17SOL 134 32160	S4E17SOL 150 54000	S4E17SOL 150 36000			
60	S4A12SOL 11 3960	S4A12SOL 11 2640	S4A12SOL 13 4680	S4A12SOL 13 3120																			
60	S4A18SOL 12 4320	S4A18SOL 12 2880	S4A18SOL 17 6120	S4A18SOL 17 4080																			
60			S4B12SOL 20 7200	S4B12SOL 20 4800	S4B12SOL 22 7920	S4B12SOL 22 5280																	
60					S4C13SOL 27 9720	S4C13SOL 27 6480	S4C13SOL 39 14040	S4C13SOL 39 9360															
60					S4C19SOL 30 10800	S4C19SOL 30 7200	S4C19SOL 42 15120	S4C19SOL 42 10080	S4C19SOL 51 18360	S4C19SOL 51 12240	S4C19SOL 58 20880	S4C19SOL 58 13920											
60							S4D13SOL 42 15120	S4D13SOL 42 10080	S4D13SOL 55 19800	S4D13SOL 55 13200	S4D13SOL 64 23040	S4D13SOL 64 15360											
60					S4D17SOL 32 11520	S4D17SOL 32 7680	S4D17SOL 46 16560	S4D17SOL 46 11040	S4D17SOL 56 20160	S4D17SOL 56 13440	S4D17SOL 66 23760	S4D17SOL 66 15840	S4D17SOL 74 26640	S4D17SOL 74 17760	S4D17SOL 87 31320	S4D17SOL 87 20880							
60															S4E17SOL 89 32040	S4E17SOL 89 21360	S4E17SOL 111 39960	S4E17SOL 111 26640	S4E17SOL 132 47520	S4E17SOL 132 31680			
70	S4A18SOL 9 3240	S4A18SOL 9 2160	S4A18SOL 15 5400	S4A18SOL 15 3600																			
70	S4B24SOL 11 3960	S4B24SOL 11 2640	S4B24SOL 18 6480	S4B24SOL 18 4320	S4B24SOL 23 8280	S4B24SOL 23 5520	S4B24SOL 28 10080	S4B24SOL 28 6720	S4B24SOL 32 11520	S4B24SOL 32 7680	S4B24SOL 35 12600	S4B24SOL 35 8400											
70					S4C19SOL 22 7920	S4C19SOL 22 5280	S4C19SOL 33 11880	S4C19SOL 33 7920	S4C19SOL 43 15480	S4C19SOL 43 10320	S4C19SOL 51 18360	S4C19SOL 51 12240											

ISOLAR BOREPUMP SELECTION BASED ON AVERAGE 6 SOLAR HOURS/DAY SUMMER, 4 SOLAR HOURS/DAY WINTER													LITRES/MIN, LITRES/DAY									
HEAD M	400 W		600 W		800 W		1000 W		1200 W		1400 W		1600 W		2000 W		2400 W		2800 W		3200 W	
	SUMMER	WINTER	SUMMER	WINTER	SUMMER	WINTER	SUMMER	WINTER	SUMMER	WINTER	SUMMER	WINTER	SUMMER	WINTER	SUMMER	WINTER	SUMMER	WINTER	SUMMER	WINTER	SUMMER	WINTER
70					S4C25SOL	S4C25SOL	S4C25SOL	S4C25SOL	S4C25SOL	S4C25SOL	S4C25SOL	S4C25SOL	S4C25SOL	S4C25SOL								
					27	27	36	36	43	43	49	49	55	55								
					9720	6480	12960	8640	15480	10320	17640	11760	19800	13200								
70					S4D17SOL	S4D17SOL	S4D17SOL	S4D17SOL	S4D17SOL	S4D17SOL	S4D17SOL	S4D17SOL	S4D17SOL	S4D17SOL	S4D17SOL	S4D17SOL	S4D17SOL	S4D17SOL	S4D17SOL	S4D17SOL	S4D17SOL	S4D17SOL
					32	32	44	44	56	56	65	65	76	76								
					11520	7680	15840	10560	20160	13440	23400	15600	27360	18240								
70															S4E17SOL	S4E17SOL	S4E17SOL	S4E17SOL	S4E17SOL	S4E17SOL	S4E17SOL	S4E17SOL
															68	68	91	91	112	112		
															24480	16320	32760	21840	40320	26880		
80	S4A18SOL	S4A18SOL	S4A18SOL	S4A18SOL																		
	7	7	13	13																		
	2520	1680	4680	3120																		
80			S4B24SOL	S4B24SOL	S4B24SOL	S4B24SOL	S4B24SOL	S4B24SOL	S4B24SOL	S4B24SOL	S4B24SOL	S4B24SOL	S4B24SOL	S4B24SOL								
			15	15	21	21	26	26	29	29	33	33										
			5400	3600	7560	5040	9360	6240	10440	6960	11880	7920										
80					S4C19SOL	S4C19SOL	S4C19SOL	S4C19SOL	S4C19SOL	S4C19SOL	S4C19SOL	S4C19SOL	S4C19SOL	S4C19SOL								
					25	25	35	35	43	43												
					9000	6000	12600	8400	15480	10320												
80					S4C25SOL	S4C25SOL	S4C25SOL	S4C25SOL	S4C25SOL	S4C25SOL	S4C25SOL	S4C25SOL	S4C25SOL	S4C25SOL								
					20	20	30	30	37	37	44	44	50	50								
					7200	4800	10800	7200	13320	8880	15840	10560	18000	12000								
80									S4D17SOL	S4D17SOL	S4D17SOL	S4D17SOL	S4D17SOL	S4D17SOL	S4D17SOL	S4D17SOL	S4D17SOL	S4D17SOL	S4D17SOL	S4D17SOL	S4D17SOL	S4D17SOL
									33	33	46	46	56	56	63	63						
									11880	7920	16560	11040	20160	13440	22680	15120						
80													S4E17SOL	S4E17SOL	S4E17SOL	S4E17SOL	S4E17SOL	S4E17SOL	S4E17SOL	S4E17SOL	S4E17SOL	S4E17SOL
													22	22	50	50	72	72	93	93		
													7920	5280	18000	12000	25920	17280	33480	22320		
90			S4A18SOL	S4A18SOL																		
			11	11																		
			3960	2640																		
90	S4A36SOL	S4A36SOL	S4A36SOL	S4A36SOL	S4A36SOL	S4A36SOL	S4A36SOL	S4A36SOL	S4A36SOL	S4A36SOL	S4A36SOL	S4A36SOL	S4A36SOL	S4A36SOL								
	7	7	11	11	15	15	18	18	21	21	23	23										
	2520	1680	3960	2640	5400	3600	6480	4320	7560	5040	8280	5520										
90			S4B24SOL	S4B24SOL	S4B24SOL	S4B24SOL	S4B24SOL	S4B24SOL	S4B24SOL	S4B24SOL	S4B24SOL	S4B24SOL	S4B24SOL	S4B24SOL								
			12	12	18	18	23	23	27	27	31	31										
			4320	2880	6480	4320	8280	5520	9720	6480	11160	7440										
90			S4B32SOL	S4B32SOL	S4B32SOL	S4B32SOL	S4B32SOL	S4B32SOL	S4B32SOL	S4B32SOL	S4B32SOL	S4B32SOL	S4B32SOL	S4B32SOL	S4B32SOL	S4B32SOL	S4B32SOL	S4B32SOL	S4B32SOL	S4B32SOL	S4B32SOL	S4B32SOL
			12	12	18	18	23	23	26	26	29	29	32	32								
			4320	2880	6480	4320	8280	5520	9360	6240	10440	6960	11520	7680								
90									S4C19SOL	S4C19SOL	S4C19SOL	S4C19SOL										
									28	28	34	34										
									10080	6720	12240	8160										
90					S4C25SOL	S4C25SOL	S4C25SOL	S4C25SOL	S4C25SOL	S4C25SOL	S4C25SOL	S4C25SOL	S4C25SOL	S4C25SOL								
					23	23	32	32	37	37	44	44										
					8280	5520	11520	7680	13320	8880	15840	10560										
90					S4C39SOL	S4C39SOL	S4C39SOL	S4C39SOL	S4C39SOL	S4C39SOL	S4C39SOL	S4C39SOL	S4C39SOL	S4C39SOL	S4C39SOL	S4C39SOL	S4C39SOL	S4C39SOL	S4C39SOL	S4C39SOL	S4C39SOL	S4C39SOL
					24	24	32	32	37	37	43	43	53	53	61	61	66	66	66	66	66	66
					8640	5760	11520	7680	13320	8880	15480	10320	19080	12720	21960	14640	23760	15840	23760	15840	23760	15840
90									S4D17SOL	S4D17SOL	S4D17SOL	S4D17SOL	S4D17SOL	S4D17SOL	S4D17SOL	S4D17SOL	S4D17SOL	S4D17SOL	S4D17SOL	S4D17SOL	S4D17SOL	S4D17SOL
									34	34	46	46	48	48								
									12240	8160	16560	11040	17280	11520								
90									S4D25SOL	S4D25SOL	S4D25SOL	S4D25SOL	S4D25SOL	S4D25SOL	S4D25SOL	S4D25SOL	S4D25SOL	S4D25SOL	S4D25SOL	S4D25SOL	S4D25SOL	S4D25SOL
									38	38	47	47	65	65	78	78	86	86				
									13680	9120	16920	11280	23400	15600	28080	18720	30960	20640				

ISOLAR BOREPUMP SELECTION BASED ON AVERAGE 6 SOLAR HOURS/DAY SUMMER, 4 SOLAR HOURS/DAY WINTER												LITRES/MIN, LITRES/DAY											
HEAD M	400 W		600 W		800 W		1000 W		1200 W		1400 W		1600 W		2000 W		2400 W		2800 W		3200 W		
	SUMMER	WINTER	SUMMER	WINTER	SUMMER	WINTER	SUMMER	WINTER	SUMMER	WINTER	SUMMER	WINTER	SUMMER	WINTER	SUMMER	WINTER	SUMMER	WINTER	SUMMER	WINTER	SUMMER	WINTER	
100			S4A18SOL	S4A18SOL																			
			9	9																			
			3240	2160																			
100	S4A36SOL	S4A36SOL	S4A36SOL	S4A36SOL	S4A36SOL	S4A36SOL	S4A36SOL	S4A36SOL	S4A36SOL	S4A36SOL	S4A36SOL	S4A36SOL	S4A36SOL	S4A36SOL	S4A36SOL	S4A36SOL	S4A36SOL	S4A36SOL	S4A36SOL	S4A36SOL	S4A36SOL	S4A36SOL	
	5	5	10	10	14	14	17	17	20	20	22	22											
	1800	1200	3600	2400	5040	3360	6120	4080	7200	4800	7920	5280											
100					S4B24SOL	S4B24SOL	S4B24SOL	S4B24SOL	S4B24SOL	S4B24SOL	S4B24SOL	S4B24SOL	S4B24SOL	S4B24SOL	S4B24SOL	S4B24SOL	S4B24SOL	S4B24SOL	S4B24SOL	S4B24SOL	S4B24SOL	S4B24SOL	
					15	15	21	21	25	25	28	28											
					5400	3600	7560	5040	9000	6000	10080	6720											
100			S4B32SOL	S4B32SOL	S4B32SOL	S4B32SOL	S4B32SOL	S4B32SOL	S4B32SOL	S4B32SOL	S4B32SOL	S4B32SOL	S4B32SOL	S4B32SOL	S4B32SOL	S4B32SOL	S4B32SOL	S4B32SOL	S4B32SOL	S4B32SOL	S4B32SOL	S4B32SOL	
			11	11	16	16	21	21	24	24	27	27	30	30									
			3960	2640	5760	3840	7560	5040	8640	5760	9720	6480	10800	7200									
100									S4C25SOL	S4C25SOL	S4C25SOL	S4C25SOL	S4C25SOL	S4C25SOL	S4C25SOL	S4C25SOL	S4C25SOL	S4C25SOL	S4C25SOL	S4C25SOL	S4C25SOL	S4C25SOL	
									26	26	32	32	38	38									
									9360	6240	11520	7680	13680	9120									
100								S4C39SOL	S4C39SOL	S4C39SOL	S4C39SOL	S4C39SOL	S4C39SOL	S4C39SOL	S4C39SOL	S4C39SOL	S4C39SOL	S4C39SOL	S4C39SOL	S4C39SOL	S4C39SOL	S4C39SOL	
								20	20	27	27	33	33	39	39	49	49	58	58	64	64	66	66
								7200	4800	9720	6480	11880	7920	14040	9360	17640	11760	20880	13920	23040	15360	23760	15840
100									S4D25SOL	S4D25SOL	S4D25SOL	S4D25SOL	S4D25SOL	S4D25SOL	S4D25SOL	S4D25SOL	S4D25SOL	S4D25SOL	S4D25SOL	S4D25SOL	S4D25SOL	S4D25SOL	
									22	22	30	30	39	39	55	55	69	69	80	80	80	80	
									7920	5280	10800	7200	14040	9360	19800	13200	24840	16560	28800	19200			
110			S4A36SOL	S4A36SOL	S4A36SOL	S4A36SOL	S4A36SOL	S4A36SOL	S4A36SOL	S4A36SOL	S4A36SOL	S4A36SOL	S4A36SOL	S4A36SOL	S4A36SOL	S4A36SOL	S4A36SOL	S4A36SOL	S4A36SOL	S4A36SOL	S4A36SOL	S4A36SOL	
			9	9	13	13	17	17	19	19	26	26											
			3240	2160	4680	3120	6120	4080	6840	4560	9360	6240											
110					S4B24SOL	S4B24SOL	S4B24SOL	S4B24SOL	S4B24SOL	S4B24SOL	S4B24SOL	S4B24SOL	S4B24SOL	S4B24SOL	S4B24SOL	S4B24SOL	S4B24SOL	S4B24SOL	S4B24SOL	S4B24SOL	S4B24SOL	S4B24SOL	
					12	12	17	17	23	23	25	25											
					4320	2880	6120	4080	8280	5520	9000	6000											
110					S4B32SOL	S4B32SOL	S4B32SOL	S4B32SOL	S4B32SOL	S4B32SOL	S4B32SOL	S4B32SOL	S4B32SOL	S4B32SOL	S4B32SOL	S4B32SOL	S4B32SOL	S4B32SOL	S4B32SOL	S4B32SOL	S4B32SOL	S4B32SOL	
					13	13	18	18	23	23	26	26	28	28									
					4680	3120	6480	4320	8280	5520	9360	6240	10080	6720									
110									S4C25SOL	S4C25SOL	S4C25SOL	S4C25SOL	S4C25SOL	S4C25SOL	S4C25SOL	S4C25SOL	S4C25SOL	S4C25SOL	S4C25SOL	S4C25SOL	S4C25SOL	S4C25SOL	
									20	20	27	27	34	34									
									7200	4800	9720	6480	12240	8160									
110									S4C39SOL	S4C39SOL	S4C39SOL	S4C39SOL	S4C39SOL	S4C39SOL	S4C39SOL	S4C39SOL	S4C39SOL	S4C39SOL	S4C39SOL	S4C39SOL	S4C39SOL	S4C39SOL	
									23	23	28	28	35	35	45	45	53	53	60	60	63	63	
									8280	5520	10080	6720	12600	8400	16200	10800	19080	12720	21600	14400	22680	15120	
110													S4D25SOL	S4D25SOL	S4D25SOL	S4D25SOL	S4D25SOL	S4D25SOL	S4D25SOL	S4D25SOL	S4D25SOL	S4D25SOL	
													34	34	48	48	61	61	73	73	73	73	
													12240	8160	17280	11520	21960	14640	26280	17520			
120					S4B24SOL	S4B24SOL	S4B24SOL	S4B24SOL	S4B24SOL	S4B24SOL	S4B24SOL	S4B24SOL	S4B24SOL	S4B24SOL	S4B24SOL	S4B24SOL	S4B24SOL	S4B24SOL	S4B24SOL	S4B24SOL	S4B24SOL	S4B24SOL	
					10	10	15	15	20	20	21	21											
					3600	2400	5400	3600	7200	4800	7560	5040											
120			S4A36SOL	S4A36SOL	S4A36SOL	S4A36SOL	S4A36SOL	S4A36SOL	S4A36SOL	S4A36SOL	S4A36SOL	S4A36SOL	S4A36SOL	S4A36SOL	S4A36SOL	S4A36SOL	S4A36SOL	S4A36SOL	S4A36SOL	S4A36SOL	S4A36SOL	S4A36SOL	
			8	8	12	12	16	16	18	18	24	24											
			2880	1920	4320	2880	5760	3840	6480	4320	8640	5760											
120					S4B32SOL	S4B32SOL	S4B32SOL	S4B32SOL	S4B32SOL	S4B32SOL	S4B32SOL	S4B32SOL	S4B32SOL	S4B32SOL	S4B32SOL	S4B32SOL	S4B32SOL	S4B32SOL	S4B32SOL	S4B32SOL	S4B32SOL	S4B32SOL	
					12	12	17	17	21	21	24	24	27	27									
					4320	2880	6120	4080	7560	5040	8640	5760	9720	6480									
120											S4C25SOL	S4C25SOL	S4C25SOL	S4C25SOL	S4C25SOL	S4C25SOL	S4C25SOL	S4C25SOL	S4C25SOL	S4C25SOL	S4C25SOL	S4C25SOL	
											22	22	28	28									
											7920	5280	10080	6720									
120													S4D25SOL	S4D25SOL	S4D25SOL	S4D25SOL	S4D25SOL	S4D25SOL	S4D25SOL	S4D25SOL	S4D25SOL	S4D25SOL	
													25	25	41	41	54	54	58	58	58	58	
													9000	6000	14760	9840	19440	12960	20880	13920			

SOLAR BOREPUMP SELECTION BASED ON AVERAGE 6 SOLAR HOURS/DAY SUMMER, 4 SOLAR HOURS/DAY WINTER												LITRES/MIN, LITRES/DAY												
HEAD M	400 W		600 W		800 W		1000 W		1200 W		1400 W		1600 W		2000 W		2400 W		2800 W		3200 W			
	SUMMER	WINTER	SUMMER	WINTER	SUMMER	WINTER	SUMMER	WINTER	SUMMER	WINTER	SUMMER	WINTER	SUMMER	WINTER	SUMMER	WINTER	SUMMER	WINTER	SUMMER	WINTER	SUMMER	WINTER		
130			S4A36SOL 6 2160	S4A36SOL 6 1440	S4A36SOL 11 3960	S4A36SOL 11 2640	S4A36SOL 14 5040	S4A36SOL 14 3360	S4A36SOL 17 6120	S4A36SOL 17 4080	S4A36SOL 19 6840	S4A36SOL 19 4560												
130							S4B24SOL 13 4680	S4B24SOL 13 3120	S4B24SOL 17 6120	S4B24SOL 17 4080	S4B24SOL 17 6120	S4B24SOL 17 4080												
130							S4B32SOL 15 5400	S4B32SOL 15 3600	S4B32SOL 18 6480	S4B32SOL 18 4320	S4B32SOL 22 7920	S4B32SOL 22 5280	S4B32SOL 25 9000	S4B32SOL 25 6000										
130			S4B48SOL 11 3960	S4B48SOL 11 2640	S4B48SOL 15 5400	S4B48SOL 15 3600	S4B48SOL 19 6840	S4B48SOL 19 4560	S4B48SOL 22 7920	S4B48SOL 22 5280	S4B48SOL 25 9000	S4B48SOL 25 6000	S4B48SOL 29 10440	S4B48SOL 29 6960	S4B48SOL 32 11520	S4B48SOL 32 7680	S4B48SOL 35 12600	S4B48SOL 35 8400	S4B48SOL 36 12960	S4B48SOL 36 8640				
130									S4C39SOL 20 7200	S4C39SOL 20 4800	S4C39SOL 27 9720	S4C39SOL 27 6480	S4C39SOL 37 13320	S4C39SOL 37 8880	S4C39SOL 45 16200	S4C39SOL 45 10800	S4C39SOL 53 19080	S4C39SOL 53 12720	S4C39SOL 56 20160	S4C39SOL 56 13440				
130													S4D25SOL 34	S4D25SOL 34	S4D25SOL 47	S4D25SOL 47	S4D25SOL 50	S4D25SOL 50						
140			S4A36SOL 10 3600	S4A36SOL 10 2400	S4A36SOL 13 4680	S4A36SOL 13 3120	S4A36SOL 16 5760	S4A36SOL 16 3840	S4A36SOL 18 6480	S4A36SOL 18 4320														
140							S4B32SOL 13 4680	S4B32SOL 13 3120	S4B32SOL 17 6120	S4B32SOL 17 4080	S4B32SOL 20 7200	S4B32SOL 20 4800	S4B32SOL 23 8280	S4B32SOL 23 5520										
140							S4B48SOL 13 4680	S4B48SOL 13 3120	S4B48SOL 17 6120	S4B48SOL 17 4080	S4B48SOL 20 7200	S4B48SOL 20 4800	S4B48SOL 24 8640	S4B48SOL 24 5760	S4B48SOL 28 10080	S4B48SOL 28 6720	S4B48SOL 31 11160	S4B48SOL 31 7440	S4B48SOL 34 12240	S4B48SOL 34 8160	S4B48SOL 36 12960	S4B48SOL 36 8640		
140													S4C39SOL 23 8280	S4C39SOL 23 5520	S4C39SOL 34 12240	S4C39SOL 34 8160	S4C39SOL 42 15120	S4C39SOL 42 10080	S4C39SOL 50 18000	S4C39SOL 50 12000	S4C39SOL 53 19080	S4C39SOL 53 12720		
150			S4A36SOL 8 2880	S4A36SOL 8 1920	S4A36SOL 12 4320	S4A36SOL 12 2880	S4A36SOL 14 5040	S4A36SOL 14 3360	S4A36SOL 17 6120	S4A36SOL 17 4080														
150							S4B32SOL 10 3600	S4B32SOL 10 2400	S4B32SOL 14 5040	S4B32SOL 14 3360	S4B32SOL 18 6480	S4B32SOL 18 4320	S4B32SOL 22 7920	S4B32SOL 22 5280										
150							S4B48SOL 11 3960	S4B48SOL 11 2640	S4B48SOL 15 5400	S4B48SOL 15 3600	S4B48SOL 19 6840	S4B48SOL 19 4560	S4B48SOL 22 7920	S4B48SOL 22 5280	S4B48SOL 26 9360	S4B48SOL 26 6240	S4B48SOL 30 10800	S4B48SOL 30 7200	S4B48SOL 34 12240	S4B48SOL 34 8160	S4B48SOL 36 12240	S4B48SOL 36 8160		
150															S4C39SOL 30 10800	S4C39SOL 30 7200	S4C39SOL 38 13680	S4C39SOL 38 9120	S4C39SOL 46 16560	S4C39SOL 46 11040	S4C39SOL 48 17280	S4C39SOL 48 11520		

ISOLAR BOREPUMP SELECTION BASED ON AVERAGE 6 SOLAR HOURS/DAY SUMMER, 4 SOLAR HOURS/DAY WINTER												LITRES/MIN, LITRES/DAY											
HEAD M	400 W		600 W		800 W		1000 W		1200 W		1400 W		1600 W		2000 W		2400 W		2800 W		3200 W		
	SUMMER	WINTER	SUMMER	WINTER	SUMMER	WINTER	SUMMER	WINTER	SUMMER	WINTER	SUMMER	WINTER	SUMMER	WINTER	SUMMER	WINTER	SUMMER	WINTER	SUMMER	WINTER	SUMMER	WINTER	
160					S4A36SOL	S4A36SOL	S4A36SOL	S4A36SOL	S4A36SOL	S4A36SOL	S4A36SOL	S4A36SOL					10080	6720	12960	8640	12960	8640	
					7	7	11	11	13	13	15	15											
					2520	1680	3960	2640	4680	3120	5400	3600											
160									S4B32SOL	S4B32SOL	S4B32SOL	S4B32SOL	S4B32SOL	S4B32SOL									
									13	13	17	17	21	21									
									4680	3120	6120	4080	7560	5040									
160									S4B48SOL	S4B48SOL	S4B48SOL	S4B48SOL	S4B48SOL	S4B48SOL	S4B48SOL	S4B48SOL	S4B48SOL	S4B48SOL	S4B48SOL	S4B48SOL	S4B48SOL	S4B48SOL	
									14	14	18	18	20	20	25	25	29	29	33	33	33	33	
									5040	3360	6480	4320	7200	4800	9000	6000	10440	6960	11880	7920	11880	7920	
160														S4C39SOL	S4C39SOL	S4C39SOL	S4C39SOL	S4C39SOL	S4C39SOL	S4C39SOL	S4C39SOL	S4C39SOL	
														27	27	35	35	43	43	45	45	45	
														9720	6480	12600	8400	15480	10320	16200	10800	10800	
180					S4A36SOL	S4A36SOL	S4A36SOL	S4A36SOL	S4A36SOL	S4A36SOL	S4A36SOL	S4A36SOL											
					8	8	11	11	13	13	13	13											
					2880	1920	3960	2640	4680	3120	4680	3120											
180									S4B32SOL	S4B32SOL	S4B32SOL	S4B32SOL	S4B32SOL	S4B32SOL									
									13	13	15	15	15	15									
									4680	3120	5400	3600	5400	3600									
180									S4B48SOL	S4B48SOL	S4B48SOL	S4B48SOL	S4B48SOL	S4B48SOL	S4B48SOL	S4B48SOL	S4B48SOL	S4B48SOL	S4B48SOL	S4B48SOL	S4B48SOL	S4B48SOL	
									11	11	14	14	17	17	22	22	27	27	31	31	31	31	
									3960	2640	5040	3360	6120	4080	7920	5280	9720	6480	11160	7440	11160	7440	
180														S4C39SOL	S4C39SOL	S4C39SOL	S4C39SOL	S4C39SOL	S4C39SOL	S4C39SOL	S4C39SOL		
														28	28	36	36	36	36	36	36	36	
200					S4A36SOL	S4A36SOL	S4A36SOL	S4A36SOL	S4A36SOL	S4A36SOL	S4A36SOL	S4A36SOL											
					6	6	9	9	10	10	10	10											
					2160	1440	3240	2160	3600	2400	3600	2400											
200									S4B48SOL	S4B48SOL	S4B48SOL	S4B48SOL	S4B48SOL	S4B48SOL	S4B48SOL	S4B48SOL	S4B48SOL	S4B48SOL	S4B48SOL	S4B48SOL	S4B48SOL	S4B48SOL	
									11	11	14	14	19	19	24	24	28	28	28	28	28	28	
									3960	2640	5040	3360	6840	4560	8640	5760	10080	6720	10080	6720	10080	6720	
200														S4C39SOL	S4C39SOL	S4C39SOL	S4C39SOL	S4C39SOL	S4C39SOL	S4C39SOL	S4C39SOL		
														21	21	24	24	24	24	24	24	24	
														7560	5040	8640	5760	8640	5760	8640	5760	8640	
220													S4B48SOL	S4B48SOL	S4B48SOL	S4B48SOL	S4B48SOL	S4B48SOL	S4B48SOL	S4B48SOL	S4B48SOL		
									12	12	17	17	22	22	22	22	25	25	25	25	25	25	
									4320	2880	6120	4080	7920	5280	9000	6000	9000	6000	9000	6000	9000	6000	
240														S4B48SOL	S4B48SOL	S4B48SOL	S4B48SOL	S4B48SOL	S4B48SOL	S4B48SOL	S4B48SOL		
														15	15	20	20	21	21	21	21	21	
														5400	3600	7200	4800	7560	5040	7560	5040	7560	
260														S4B48SOL	S4B48SOL	S4B48SOL	S4B48SOL	S4B48SOL	S4B48SOL	S4B48SOL	S4B48SOL		
														13	13	18	18	18	18	18	18	18	
														4680	3120	6480	4320	6480	4320	6480	4320	6480	



# 7. iSOLAR SELECTION MATRIX - NZ

For New Zealand

HEAD M	iSOLAR BOREPUMP SELECTION BASED ON AVERAGE 5 SOLAR HOURS/DAY SUMMER, 2.5 SOLAR HOURS/DAY WINTER								LITRES/MIN, LITRES/DAY					
	300 W		600 W		900 W		1200 W		1800 W		2400 W		3000	
	SUMMER	WINTER	SUMMER	WINTER	SUMMER	WINTER	SUMMER	WINTER	SUMMER	WINTER	SUMMER	WINTER	SUMMER	WINTER
20			S4E8SOL 84 25200	S4E8SOL 84 12600	S4E8SOL 130 39000	S4E8SOL 130 19500	S4E8SOL 161 48300	S4E8SOL 161 24150						
20									S4FSOL 220 66000	S4F7SOL 220 33000	S4FSOL 300 90000	S4F7SOL 300 45000		
30			S4C9SOL 48 14400	S4C9SOL 48 7200										
30			S4D8SOL 60 18000	S4D8SOL 60 9000	S4D8SOL 80 24000	S4D8SOL 80 12000								
30					S4E8SOL 80 24000	S4E8SOL 80 12000	S4E8SOL 112 33600	S4E8SOL 112 16800						
30					S4E12SOL 84 25200	S4E12SOL 84 12600	S4E12SOL 112 33600	S4E12SOL 112 16800	S4E12SOL 160 48000	S4E12SOL 160 24000	S4F7SOL 175 52500	S4F7SOL 175 26250		
40	S4A12SOL 13 3900	S4A12SOL 13 1950	S4A12SOL 19 5700	S4A12SOL 19 2850										
40	S4B12SOL 12 3600	S4B12SOL 12 1800	S4B12SOL 28 8400	S4B12SOL 28 4200										
40			S4C9SOL 34 10200	S4C9SOL 34 5100										
40			S4C13SOL 38 11400	S4C13SOL 38 5700	S4C13SOL 55 16500	S4C13SOL 55 8250								
40					S4D8SOL 60 18000	S4D8SOL 60 9000								
40							S4E8SOL 68 20400	S4E8SOL 68 10200						
40							S4E12SOL 81 24300	S4E12SOL 81 12150	S4E12SOL 132 39600	S4E12SOL 132 19800				
40							S4E17SOL 82 24600	S4E17SOL 82 12300	S4E17SOL 125 37500	S4E17SOL 125 18750	S4E17SOL 180 54000	S4E17SOL 180 27000		

ISOLAR BOREPUMP SELECTION BASED ON AVERAGE 5 SOLAR HOURS/DAY SUMMER, 2.5 SOLAR HOURS/DAY WINTER								LITRES/MIN, LITRES/DAY						
HEAD M	300 W		600 W		900 W SUMMER		1200 W SUMMER		1800 W SUMMER		2400 W SUMMER		3000 W SUMMER	
	SUMMER	WINTER	SUMMER	WINTER	WINTER	WINTER	WINTER	WINTER	WINTER	WINTER	WINTER	WINTER	WINTER	WINTER
50	S4A12SOL 10 3000	S4A12SOL 10 1500	S4A12SOL 19 5700	S4A12SOL 19 2850										
50	S4A18SOL 13 3900	S4A18SOL 13 1950	S4A18SOL 20 6000	S4A18SOL 20 3000										
50			S4B12SOL 25 7500	S4B12SOL 25 3750										
50			S4C13SOL 23 6900	S4C13SOL 23 3450	S4C13SOL 35 10500	S4C13SOL 35 5250								
50					S4D13SOL 50 15000	S4D13SOL 50 7500	S4D13SOL 66 19800	S4D13SOL 66 9900						
50									S4E17SOL 105 31500	S4E17SOL 105 15750	S4E17SOL 134 40200	S4E17SOL 134 20100		
60	S4A12SOL 7 2100	S4A12SOL 7 1050	S4A12SOL 12 3600	S4A12SOL 12 1800										
60	S4A18SOL 12 3600	S4A18SOL 12 1800	S4A18SOL 17 5100	S4A18SOL 17 2550										
60			S4B12SOL 20 6000	S4B12SOL 20 3000										
60					S4C13SOL 35 10500	S4C13SOL 35 5250								
60					S4C19SOL 35 10500	S4C19SOL 35 5250	S4C19SOL 51 15300	S4C19SOL 51 7650						
60					S4D13SOL 34 10200	S4D13SOL 34 5100	S4D13SOL 55 16500	S4D13SOL 55 8250						
60					S4D17SOL 45 13500	S4D17SOL 45 6750	S4D17SOL 56 16800	S4D17SOL 56 8400	S4D17SOL 85 25500	S4D17SOL 85 12750				
60									S4E12SOL 72 21600	S4E12SOL 72 10800				
60									S4E17SOL 80 24000	S4E17SOL 80 12000	S4E17SOL 111 33300	S4E17SOL 111 16650		

SOLAR BOREPUMP SELECTION BASED ON AVERAGE 5 SOLAR HOURS/DAY SUMMER, 2.5 SOLAR HOURS/DAY WINTER										LITRES/MIN, LITRES/DAY				
HEAD M	300 W		600 W		900 W		1200 W		1800 W		2400 W		3000 W	
	SUMMER	WINTER	SUMMER	WINTER	SUMMER	WINTER	SUMMER	WINTER	SUMMER	WINTER	SUMMER	WINTER	SUMMER	WINTER
70	S4A18SOL	S4A18SOL	S4A18SOL	S4A18SOL										
	7	7	15	15										
	2100	1050	4500	2250										
70			S4B24SOL	S4B24SOL	S4B24SOL	S4B24SOL	S4B24SOL	S4B24SOL						
			18	18	27	27	32	32						
			5400	2700	8100	4050	9600	4800						
70					S4C19SOL	S4C19SOL	S4C19SOL	S4C19SOL						
					28	28	43	43						
					8400	4200	12900	6450						
70					S4C25SOL	S4C25SOL	S4C25SOL	S4C25SOL	S4C25SOL	S4C25SOL				
					30	30	43	43	63	63				
					9000	4500	12900	6450	18900	9450				
70							S4D13SOL	S4D13SOL						
							40	40						
							12000	6000						
70							S4D17SOL	S4D17SOL	S4D17SOL	S4D17SOL				
							44	44	73	73				
							13200	6600	21900	10950				
70											S4E17SOL	S4E17SOL		
											91	91		
											27300	13650		
80			S4A18SOL	S4A18SOL										
			13	13										
			3900	1950										
80			S4B24SOL	S4B24SOL	S4B24SOL	S4B24SOL	S4B24SOL	S4B24SOL						
			15	15	23	23	29	29						
			4500	2250	6900	3450	8700	4350						
80							S4C19SOL	S4C19SOL						
							35	35						
							10500	5250						
80							S4C25SOL	S4C25SOL	S4C19SOL	S4C19SOL				
							37	37	57	57				
							11100	5550	17100	8550				
80							S4D17SOL	S4D17SOL	S4D17SOL	S4D17SOL				
							33	33	62	62				
							9900	4950	18600	9300				
80											S4E17SOL	S4E17SOL		
											72	72		
											21600	10800		

SOLAR BOREPUMP SELECTION BASED ON AVERAGE 5 SOLAR HOURS/DAY SUMMER, 2.5 SOLAR HOURS/DAY WINTER										LITRES/MIN, LITRES/DAY				
HEAD M	300 W		600 W		900 W		1200 W		1800 W		2400 W		3000 W	
	SUMMER	WINTER	SUMMER	WINTER	SUMMER	WINTER	SUMMER	WINTER	SUMMER	WINTER	SUMMER	WINTER	SUMMER	WINTER
90			S4A18SOL	S4A18SOL										
			11	11										
			3300	1650										
90			S4A36SOL	S4A36SOL	S4A36SOL	S4A36SOL	S4A36SOL	S4A36SOL						
			11	11	17	17	21	21						
			3300	1650	5100	2550	6300	3150						
90			S4B24SOL	S4B24SOL	S4B24SOL	S4B24SOL	S4B24SOL	S4B24SOL						
			12	12	21	21	27	27						
			3600	1800	6300	3150	8100	4050						
90			S4B32SOL	S4B32SOL	S4B32SOL	S4B32SOL	S4B32SOL	S4B32SOL	S4B32SOL	S4B32SOL				
			12	12	17	17	26	26	35	35				
			3600	1800	5100	2550	7800	3900	10500	5250				
90							S4C19SOL	S4C19SOL						
							28	28						
							8400	4200						
90							S4C25SOL	S4C25SOL	S4C25SOL	S4C25SOL				
							30	30	51	51				
							9000	4500	15300	7650				
90							S4C39SOL	S4C39SOL	S4C39SOL	S4C39SOL	S4C39SOL	S4C39SOL	S4C39SOL	S4C39SOL
							32	32	52	52	61	61	70	70
							9600	4800	15600	7800	18300	9150	21000	10500
100			S4A18SOL	S4A18SOL										
			9	9										
			2700	1350										
100			S4A36SOL	S4A36SOL	S4A36SOL	S4A36SOL	S4A36SOL	S4A36SOL						
			10	10	16	16	20	20						
			3000	1500	4800	2400	6000	3000						
100					S4B24SOL	S4B24SOL	S4B24SOL	S4B24SOL						
					17	17	25	25						
					5100	2550	7500	3750						
100			S4B32SOL	S4B32SOL	S4B32SOL	S4B32SOL	S4B32SOL	S4B32SOL	S4B32SOL	S4B32SOL				
			11	11	17	17	24	24	35	35				
			3300	1650	5100	2550	7200	3600	10500	5250				
100							S4C25SOL	S4C25SOL	S4C25SOL	S4C25SOL				
							26	26	44	44				
							7800	3900	13200	6600				
100					S4C39SOL	S4C39SOL	S4C39SOL	S4C39SOL	S4C39SOL	S4C39SOL	S4C39SOL	S4C39SOL	S4C39SOL	S4C39SOL
					22	22	27	27	44	44	58	58	65	65
					6600	3300	8100	4050	13200	6600	17400	8700	19500	9750

SOLAR BOREPUMP SELECTION BASED ON AVERAGE 5 SOLAR HOURS/DAY SUMMER, 2.5 SOLAR HOURS/DAY WINTER												LITRES/MIN, LITRES/DAY			
HEAD M	300 W		600 W		900 W		1200 W		1800 W		2400 W		3000 W		
	SUMMER	WINTER	SUMMER	WINTER	SUMMER	WINTER	SUMMER	WINTER	SUMMER	WINTER	SUMMER	WINTER	SUMMER	WINTER	
110			S4A36SOL	S4A36SOL	S4A36SOL	S4A36SOL	S4A36SOL	S4A36SOL							
			9	9	14	14	19	19							
			2700	1350	4200	2100	5700	2850							
110					S4B24SOL	S4B24SOL	S4B24SOL	S4B24SOL							
					15	15	23	23							
					4500	2250	6900	3450							
110					S4B32SOL	S4B32SOL	S4B32SOL	S4B32SOL	S4B32SOL	S4B32SOL					
					15	15	23	23	32	32					
					4500	2250	6900	3450	9600	4800					
110							S4C25SOL	S4C25SOL	S4C25SOL	S4C25SOL					
							20	20	39	39					
							6000	3000	11700	5850					
110							S4C39SOL	S4C39SOL	S4C39SOL	S4C39SOL	S4C39SOL	S4C39SOL	S4C39SOL	S4C39SOL	
							23	23	40	40	53	53	62	62	
							6900	3450	12000	6000	15900	7950	18600	9300	
120					S4B24SOL	S4B24SOL	S4B24SOL	S4B24SOL							
					12	12	20	20							
					3600	1800	6000	3000							
120			S4A36SOL	S4A36SOL	S4A36SOL	S4A36SOL	S4A36SOL	S4A36SOL							
			8	8	13	13	18	18							
			2400	1200	3900	1950	5400	2700							
120					S4B32SOL	S4B32SOL	S4B32SOL	S4B32SOL	S4B32SOL	S4B32SOL					
					13	13	21	21	32	32					
					3900	1950	6300	3150	9600	4800					
130					S4A36SOL	S4A36SOL	S4A36SOL	S4A36SOL							
					13	13	17	17							
					3900	1950	5100	2550							
130							S4B24SOL	S4B24SOL							
							17	17							
							5100	2550							
130							S4B32SOL	S4B32SOL	S4B32SOL	S4B32SOL					
							18	18	27	27					
							5400	2700	8100	4050					
130					S4B48SOL	S4B48SOL	S4B48SOL	S4B48SOL	S4B48SOL	S4B48SOL	S4B48SOL	S4B48SOL	S4B48SOL	S4B48SOL	
					14	14	19	19	27	27	32	32	35	35	
					4200	2100	5700	2850	8100	4050	9600	4800	10500	5250	
130									S4C39SOL	S4C39SOL	S4C39SOL	S4C39SOL	S4C39SOL	S4C39SOL	
									22	22	45	45	52	52	
									6600	3300	13500	6750	15600	7800	
130											S4D25SOL	S4D25SOL			
											47	47			
											14100	7050			

ISOLAR BOREPUMP SELECTION BASED ON AVERAGE 5 SOLAR HOURS/DAY SUMMER, 2.5 SOLAR HOURS/DAY WINTER												LITRES/MIN, LITRES/DAY			
HEAD M	300 W		600 W		900 W		1200 W		1800 W		2400 W		3000 W		
	SUMMER	WINTER	SUMMER	WINTER	SUMMER	WINTER	SUMMER	WINTER	SUMMER	WINTER	SUMMER	WINTER	SUMMER	WINTER	
140					S4A36SOL S4A36SOL	S4A36SOL S4A36SOL									
					12 12	16 16									
					3600 1800	4800 2400									
140					S4B48SOL S4B48SOL	S4B48SOL S4B48SOL	S4B48SOL S4B48SOL	S4B48SOL S4B48SOL	S4B48SOL S4B48SOL	S4B48SOL S4B48SOL	S4B48SOL S4B48SOL	S4B48SOL S4B48SOL	S4B48SOL S4B48SOL	S4B48SOL S4B48SOL	
					12 12	17 17	26 26	31 31	36 36						
					3600 1800	5100 2550	7800 3900	9300 4650	10800 5400						
140						S4B32SOL S4B32SOL	S4B32SOL S4B32SOL								
						16 16	26 26								
						4800 2400	7800 3900								
140										S4C39SOL S4C39SOL	S4C39SOL S4C39SOL	S4C39SOL S4C39SOL	S4C39SOL S4C39SOL	S4C39SOL S4C39SOL	
										42 42	52 52				
										12600 6300	15600 7800				
150					S4A36SOL S4A36SOL	S4A36SOL S4A36SOL									
					9 9	14 14									
					2700 1350	4200 2100									
150						S4B32SOL S4B32SOL	S4B32SOL S4B32SOL								
						14 14	22 22								
						4200 2100	6600 3300								
150						S4B48SOL S4B48SOL	S4B48SOL S4B48SOL	S4B48SOL S4B48SOL	S4B48SOL S4B48SOL	S4B48SOL S4B48SOL	S4B48SOL S4B48SOL	S4B48SOL S4B48SOL	S4B48SOL S4B48SOL	S4B48SOL S4B48SOL	
						15 15	26 26	30 30	34 34						
						4500 2250	7800 3900	9000 4500	10200 5100						
160					S4A36SOL S4A36SOL	S4A36SOL S4A36SOL									
					9 9	13 13									
					2700 1350	3900 1950									
160						S4B32SOL S4B32SOL	S4B32SOL S4B32SOL								
						13 13	22 22								
						3900 1950	6600 3300								
160						S4B48SOL S4B48SOL	S4B48SOL S4B48SOL	S4B48SOL S4B48SOL	S4B48SOL S4B48SOL	S4B48SOL S4B48SOL	S4B48SOL S4B48SOL	S4B48SOL S4B48SOL	S4B48SOL S4B48SOL	S4B48SOL S4B48SOL	
						14 14	24 24	29 29	33 33						
						4200 2100	7200 3600	8700 4350	9900 4950						
160							S4C39SOL S4C39SOL	S4C39SOL S4C39SOL	S4C39SOL S4C39SOL	S4C39SOL S4C39SOL	S4C39SOL S4C39SOL	S4C39SOL S4C39SOL	S4C39SOL S4C39SOL	S4C39SOL S4C39SOL	
							22 22	35 35	44 44						
							6600 3300	10500 5250	13200 6600						
180						S4A36SOL S4A36SOL									
						11 11									
						3300 1650									
180							S4B48SOL S4B48SOL	S4B48SOL S4B48SOL	S4B48SOL S4B48SOL	S4B48SOL S4B48SOL	S4B48SOL S4B48SOL	S4B48SOL S4B48SOL	S4B48SOL S4B48SOL	S4B48SOL S4B48SOL	
							22 22	27 27	31 31						
							6600 3300	8100 4050	9300 4650						
180							S4C39SOL S4C39SOL	S4C39SOL S4C39SOL	S4C39SOL S4C39SOL	S4C39SOL S4C39SOL	S4C39SOL S4C39SOL	S4C39SOL S4C39SOL	S4C39SOL S4C39SOL	S4C39SOL S4C39SOL	
							22 22	28 28	38 38						
							6600 3300	8400 4200	11400 5700						

## 8. iSOLAR V3 Controller timer features:

1. AUTO MODE – Controller selects the power source and uses this to run the pump depending on input signals. Bias is always DC power source.
2. When in AUTO mode, DC or AC light flashes every 10 sec depending on if it is using DC or AC power.
3. When switching between modes, the motor needs to dissipate the energy stored within the internal capacitors. This process takes 2 minutes; hence it would start a 120sec countdown timer. Repeated switching between modes will restart the dissipation cycle, causing extended delays before the pump will run.
4. The flow sensor looks for water for 3min before shutting of the signal in the controller.
5. Analogue dial for flow meter restart timer: If no flow sensor is used, set dial to zero. If a flow sensor is connected, dial can be set from 10 minutes to 60 minutes in 10-minute intervals before restart is attempted after zero flow is detected.
6. Analogue dial for generator off delay: If no generator is used, set dial to zero. If generator is connected, dial can be set from 10 minutes to 60 minutes in 10-minute intervals before the generator shuts down when DC voltage falls below the motor's starting voltage. Requires a generator that is able to accept signals from the iSOLAR controller.
7. When a generator is being used, the generator will start only when the DC voltage drops below 40V and shut off once the DC voltage goes above 90V  
(Note: The generator will run for 3min before shut down, once the voltage has gone above 90V and switches to DC)
8. If a generator is being connected, the generator starts and runs on demand when connected to iSOLAR controller. A compatible remote start generator needs to be connected via "GEN Signal" in the controller. (An Auto transfer generator system (ATS) or a generator with an integrated delay shutdown timer are compatible)
9. The iSOLAR controller can take signals from two float switches placed in a tank or similar.
10. The high-level float switch signal indicates on iSOLAR controller that the reservoir/tank is full and at this point the controller stops the pump. When the water level of the storage tank drops, the float drops and the pump returns to operation after 10 minutes. For 10min, the "TANK FULL" signal light remains on and the display starts counting down from "600" to "0." The countdown ends and the "TANK FULL" indicator goes off and the pump system restarts.
11. The low-level float switch signal indicates to the controller that the reservoir/tank is empty and at this point the controller starts the pump. When the water wells or pools without water, the water under the float drops, this signals to the iSOLAR controller the "TANK EMPTY" signal light and directs the pump system to shut down immediately. When the water level rises, the float rises and the pump returns to operation after 10 minutes. For 10 minutes, the "TANK EMPTY" signal light remains on and the display starts counting down from "600" to "0." The countdown is over and the "TANK EMPTY" indicator goes off and the pump system restarts. On power up, if tank is not full, then the iSOLAR controller powers the pump to fill the tank.



## Technical specification of V3 controller:

The iSOLAR controller is a microcontroller, designed, developed and manufactured for the DAB ICON SOLAR pump.

- It is suitable for simultaneous AC and DC incoming power supplies.
- Manually or automatically switchable between two power supplies depending on solar irradiation.
- IP65 weatherproof enclosure.
- Suitable for up to 2.4 kW (3.2hp) bore pumps.
- AC voltage input range 90 – 280 VAC. (Terminals L N & GRD)
- DC voltage input range 55 – 380VMPP (440VOC) DC for BIA-M110SOL (Terminals + - & GRD)
- DC voltage input range 90 – 380VMPP (440VOC) DC for BIA-M240SOL (Terminals + - & GRD)
- Input connections for 1 or 2 float switches. (TWL & WWL)
- Input connection for pressure switch. (WWL)
- Input connection for matching flow meter.

(FLOW SIGNAL -> REF. Setting flow meter function (on next pg.))

- Indication for power on, input power, pump on, pump off, water tank full or tank empty.
- Auto operation via 1 or 2 float switches.
- Auto operation via pressure switch.
- Auto off via flow meter.
- Auto starting of generator via volt free contacts. GEN SIGNAL • Manual operation.
- Auto switching from AC to DC supply with DC bias. DC switching point is 55V for BIA-M110SOL and 90V for BIA-M240SOL.

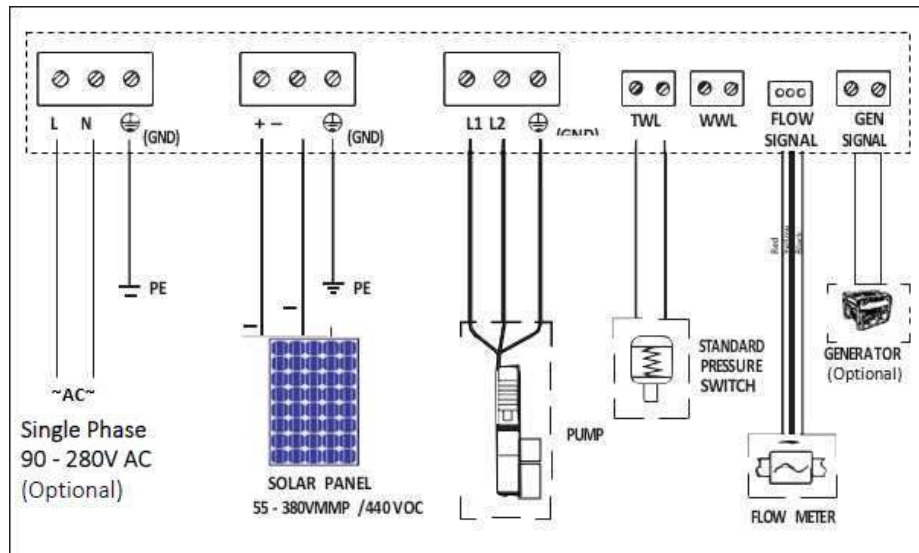

Disclaimer: Every effort has been made to publish the correct details in this brochure. No responsibility will be taken for errors, omissions or changes in product specifications. Product images are representations only.

If you have any questions please do not hesitate to contact us on our Australian Customer Service Hot Line on 1300 783 601 and our New Zealand Customer Service Hot Line on 0800 509 506



**WHITE**<sup>®</sup>  
INTERNATIONAL

Distributed by **White International Pty Ltd**

60 Ashford Avenue Milperra NSW 2214

Ph (02) 9783 6000 Fax (02) 9783 6001

SALES HOTLINE 1300 783 601 SALES FAXLINE (02) 9783 6003

Distributed by **White International NZ Ltd**

Eastfield Estate, 15G Kerwyn Ave East Tamaki, Auckland 2013

Ph 0800 509 506; Email: [sales@whiteint.co.nz](mailto:sales@whiteint.co.nz)

[www.whiteint.co.nz](http://www.whiteint.co.nz)